

**Most Excellent Productions Tradeshows**

**THE EXHIBITORS'  
HANDBOOK  
BOOK**  
**MODULAR DISPLAY SOLUTIONS**

**EXCEEDING THE ORDINARY**

**VOL.11**

**416 795 7400 Mike@mxp.to**

**BANNER STANDS | BEST OF THE BEST**..... 1-5

**BANNER STANDS | TENSION POLE & TELESCOPIC**..... 6-7

**OUTDOOR PRODUCTS**..... 8-11

**DFA | ECONOMY DISPLAY PRODUCTS**..... 12-14

**BACKWALLS & INFO CENTERS**..... 15

**HOPUP | TENSION FABRIC**..... 16-17

**POPOP DISPLAY SYSTEMS | CASES**..... 18-22

**FORMULATE | EXHIBIT BOOTHS**..... 23-26

**FORMULATE | HANGING STRUCTURES**..... 27-29

**TABLE THROWS AND RUNNERS**..... 30

**FOLDING DISPLAY PANELS**..... 31-35

**COUNTERS & KIOSKS**..... 36-38

**VECTOR WALL FRAMES**..... 39

**LINEAR DISPLAY SYSTEMS**..... 40-45

**ORBITAL EXPRESS TRUSS**..... 46-61

**LITERATURE RACKS**..... 62

**DISPLAY LIGHTING**..... 63

**CASES**..... 64

**DISPLAY ADDITIONS**..... 65

**SYMBOLS USED IN THE EXHIBITORS' HANDBOOK:**



premium product



product can be recycled  
(does not include graphic application)



affordable product



new addition to  
The Exhibitors' Handbook



economy product



product comes with a carry  
bag or case

## Most Excellent Productions Tradeshows

### ORCHID

33.5"  
WIDE ORCHID

- standard height= 76.75"
- quick to assemble and easy to use
- bamboo base, rail and pole are a sustainable choice
- slide graphic rail
- includes carry bag



**Most Excellent Productions Tradeshows**



**IMAGINE**

31.5" WIDE IMG

- variable height= 29.5"- 83.35"
- graphic tensioner
- anti-slip strips along base
- integrated pole storage
- telescopic pole
- interchangeable graphic cassette



**BARRACUDA**

31.5" WIDE BCD

- variable height= 29.5"- 83.35"
- graphic tensioner
- integrated pole storage
- telescopic pole



**EXCALIBUR**

31.5" WIDE EXC

- variable height= 29.5"- 83.35"
- double sided
- graphic tensioner
- integrated pole storage
- telescopic pole



**ADVANCE**

31.5" WIDE ADV

- variable height= 29.5"- 83.35"
- double sided
- graphic tensioner
- anti-slip strips along base
- integrated pole storage
- interchangeable graphic cassette
- telescopic pole



## Most Excellent Productions Tradeshows

### ORIENT

**31.5" WIDE** silver: ONT-800-S  
black: ONT-800-B

**35.5" WIDE** silver: ONT-920-S  
black: ONT-920-B

**39.25" WIDE** silver: ONT-1000-S  
black: ONT-1000-B

- standard height= 83.25"
- anodized silver or black
- molded end plates
- 3-piece bungee corded pole



### ORIENT 2

**31.5" WIDE** silver: ONT-800-DBL-S  
black: ONT-800-DBL-B

**35.5" WIDE** silver: ONT-920-DBL-S  
black: ONT-920-DBL-B

**39.25" WIDE** silver: ONT-1000-DBL-S  
black: ONT-1000-DBL-B

- standard height= 83.25"
- double-sided
- anodized silver or black
- molded end plates
- 3-piece bungee corded pole



### BLADE LX

**33.5" WIDE** BLD-LX-GRY

- standard height= 83.25"
- features a gunmetal anodized body & cast chrome end plates
- roller access via flip-top lid & removable self-locking graphic roller mechanism
- quick change graphic slider
- adjustable feet on base are useful on uneven floors
- 3-piece bungee corded pole & premium top rail



### CONTENDER

**23.5" WIDE** silver: CN-24-S  
black: CN-24-B

**29.5" WIDE** silver: CN-30-S  
black: CN-30-B

**35.5" WIDE** silver: CN-36-S  
black: CN-36-B

**47.5" WIDE** black: CN-48-B

- standard height= 77.5" or 105" high with optional 4th pole
- swivel-out foot
- powder coated silver or black finish
- laser cut steel ends & swaged pole



416 795 7400 Mike@mxp.to

## Most Excellent Productions Tradeshows

### ELEVATE

31.5"  
WIDE ELEVATE

- over 8' tall
- telescopic pole (4 piece)
- roller access via flip-top lid and removable self-locking graphic roller mechanism
- variable height 32" – 96"
- black aluminum body with chrome endcaps



**Most Excellent Productions Tradeshows**



**PACIFIC**

31.5" WIDE PAC-800-S

35.5" WIDE PAC-920-S

39.25" WIDE PAC-1000-S

- standard height= 83.75"
- anodized silver
- molded end plates
- swivel-out foot
- 3-piece bungee corded pole



**BLOK**

33.5" WIDE BLOK **NEW**

- standard height= 78.5" + bleed
- attractive black base with chrome endcaps
- includes carry bag
- bungee pole
- quick and easy to assemble



**416 795 7400 Mike@mxp.to**

## LIGHTNING

31" WIDE LTNG

- standard height= 77"
- snap-lock graphic rails
- 3-piece bungee corded pole





# DASH LITERATURE POCKET

## Most Excellent Productions Tradeshows



31.5" WIDE DSH-M-LR

- recommended graphic height= 44"
- separate 3 pocket literature dispenser option to attach to a Dash unit. Black mesh pockets



## DASH MEGA 1 & 2

36" WIDE single sided: DSH-ME double sided: DSH-ME-2

- variable height= up to 93.5"
- stable, anodized aluminum
- quick & easy to erect



## DASH 1 & 2

31.5" WIDE single sided: DSH-M-1 double sided: DSH-M-2

- variable height= up to 78.5"
- stable, anodized aluminum
- quick & easy to erect



## PEGASUS

52.5"-95" WIDE silver: PGSUS-S black: PGSUS-B

## PEGASUS MINI

27.5"-48" WIDE silver: PGSUS-MIN-S black: PGSUS-MIN-B

- both feature variable height= 36.5"- 96"
- backwall or backdrop
- single or double sided
- dual telescopic poles



## UNO

31.5" WIDE UN-I-ST

36" WIDE UN-I-MG

48" WIDE UN-I-MO

- variable height= 35"- 85.5"
- powder coated black weighted base



416 795 7400 Mike@mxp.to

WIND DANCER LT Most Excellent Productions Tradeshows

31.5" WIDE WIND-LT

- adjustable height= up to 13'6"
- hollow base can be filled with either water or sand as weighing agent
- easy to position, erect, and remove



43" WIDE WIND-MX



- adjustable height= up to 17'3"
- flag is approximately 3'6" wide
- hollow base can be filled with either water or sand as weighing agent
- easy to position, erect, and remove



BLAST

19'8" TALL BLST

- display a single flag or as many as 5
- bungee corded poles fabricated from hybrid aluminum/steel
- powder coated steel base
- comes with 4 ground spikes & rubber mallet



WIND DANCER SPIRE

16' TALL WIND-MX-FPCK2

- adjustable height= up to 17'3" tall
- allows a standard Wind Dancer or Wind Dancer LT to be converted to a double-sided "V" shape banner
- Wind Dancer Spire conversion is not intended for outdoor use



Wind Dancer Lanyard allows a standard Wind Dancer or Wind Dancer LT to be converted into a flagpole  
WND-MX-FPCK



SPINNAKER

8'7" TALL SPKR

- portable outdoor billboard
- maximum graphic area of 8'w x 8'h (weather & wind conditions permitting)
- single or double sided
- units can be linked together for added impact



**BLIZZARD** **Most Excellent Productions Tradeshows** **MONSOON**  
 BLZD MONSN-2



- adjustable width= up to 40"
- adjustable height= up to 80"
- base can be filled with water or sand
- easy grommet graphic attachment



- semi-portable single or double sided billboard
- strong frame is quick & easy to assemble
- includes ground stakes & bungee rope
- banner & grommets not included



**ROCKET**

- 3 legs can be filled with water or sand
- single or double sided
- spring-loaded graphic support 1/8" coroplast plastic or similar substrate recommended
- ideal for contour cut custom graphics
- graphic size may vary

**ZOOM**

- can be used indoors or out
- graphic rotates in wind
- water fillable donut adds stability
- graphic printed on flag material
- double sided graphic is available
- both floor base & ground stake included  
(additional base options available, see page 10)
- additional sizes & shapes available on page 10



**BRUTE**

- use one to hold a smaller graphic, or as many as you need to hold a large graphic
- secure grip allows for use outdoors in the elements as well as inside
- quick set-up, easy storage
- fill with water or sand, 100% empties after use
- works with a variety of graphic substrates



recommended width:  
1 Brute per 4' of signage

**WHIRLWIND**

**WHRL-WND**

- front-loading snap frames constructed from aluminum & powder-coated steel
- single or double sided
- includes clear lens cover
- quick & easy graphic changes
- dual-spring design flexes to withstand wind gusts
- compact durable base can be filled with water or sand for extra stability
- integrated wheel set



contoured base sits stable on uneven terrain



416 795 4400 Mike@mxp.to

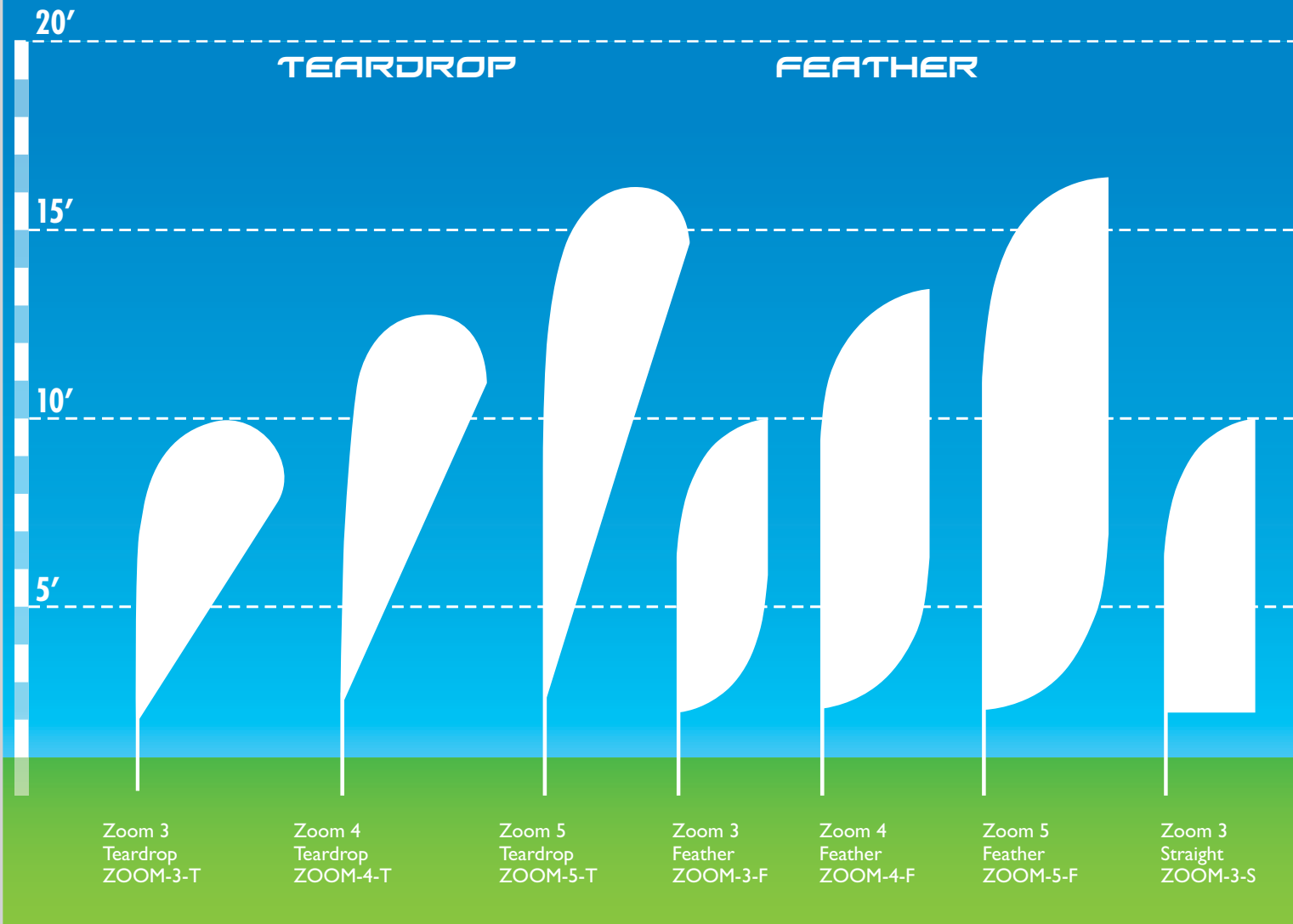

ZOOM LINE

- can be used indoors or out
- graphic rotates in wind
- water fillable donut adds stability
- graphic printed on flag material
- double sided graphic is available
- both floor base & ground stake included
- 3 shapes and 3 sizes available



Zoom hardware & bag set



ground stake (included)

for use in sand or other hard-to-stake ground



auger base (ZOOM-AUG)



drive-over base (ZOOM-VEHICLE)

designed to be positioned under vehicle tire



416 795 7400 Mike@mxp.to

STRAIGHT

WIND DANCER

BLAST

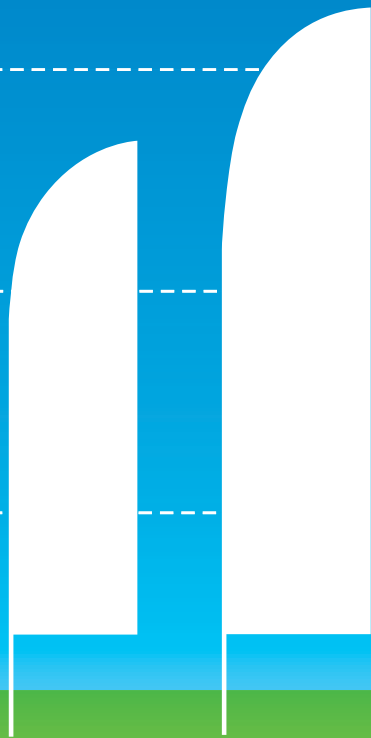

Zoom 4  
Straight  
ZOOM-4-S

Zoom 5  
Straight  
ZOOM-5-S

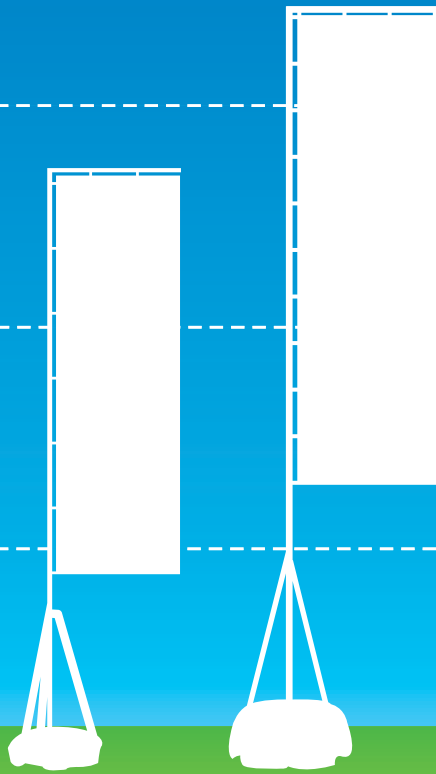

Wind Dancer LT  
WIND-LT

Wind Dancer  
WIND-MX

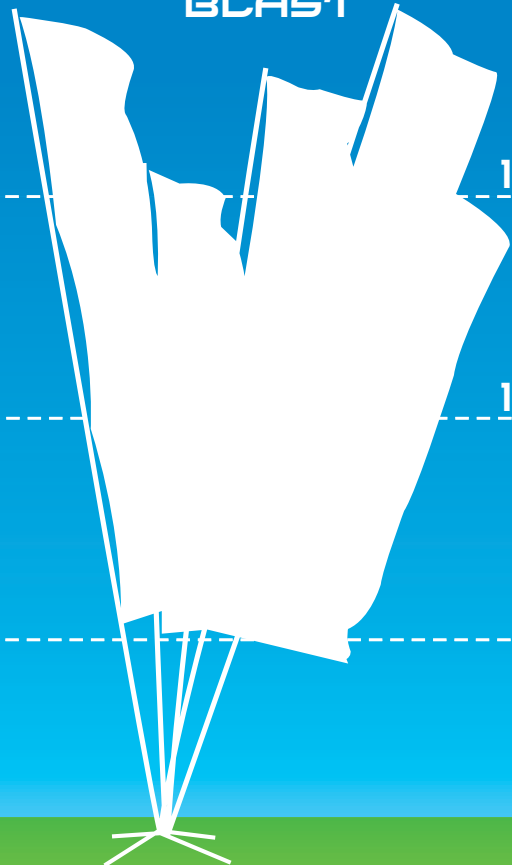

Blast  
BLST



WIND DANCER

- Wind Dancer LT= up to 13'6"
- Wind Dancer= up to 17'3"
- hollow base can be filled with either water or sand as weighing agent
- easy to position, erect, and remove



Wind Dancer bag set available  
(WIND-MX-BGSET)

BLAST

- display a single flag or as many as 5
- bungee corded poles fabricated from hybrid aluminum/steel
- powder coated steel base
- comes with 4 groundspikes & rubber mallet





## Most Excellent Productions Tradeshows

DFA (Direct from Asia) is our range of super economy banner stands & display solutions. Unlike most of our other products which are designed and developed by our team of display specialists, the DFA range of indoor and outdoor products represents the best choices from a selection of independent display producers located across the length and breadth of Asia.



### RETRACTOR 2

31" WIDE RTRC-2

- standard height= 77.5"



### RETRACTOR 4

32.75" WIDE RTRC-4

- standard height= 78.25"
- double sided



### RETRACTOR 5

36" WIDE RTRC-5

- standard height= 79.375"
- velcro graphic application



### RETRACTOR 6

31.5" WIDE RTRC-6

- standard height= 78.75"
- snap-edge graphic rail



### TELESCOPIC 1

23.5" WIDE TEL-1

- variable height= 36"-70"
- single or double sided



### TELESCOPIC 2

39" WIDE TEL-2

- variable height= 60.25"-89"



### TELESCOPIC 3

39" WIDE TEL-3

- variable height= 60.25"-89"



### TELESCOPIC 4

31" WIDE TEL-4

- standard height= 77"

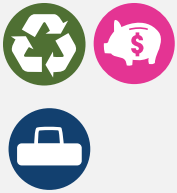

## Most Excellent Productions Tradeshows



DFA products are functional and reliable. They offer the cost effective advantage of lighter and simpler construction, making them a very economic choice.

All DFA banners come with a bag and are an eco-friendly choice.

All DFA banners come with a 45 day warranty.

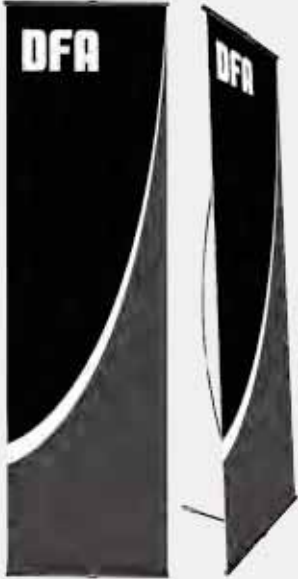

**SPRING 1-1**

24" WIDE SB-1-1

- height= 59" or 78.5"



**SPRING 1-2**

27" WIDE SB-1-2

- height= 59" or 78.5"



**SPRING 1-3**

35.25" WIDE SB-1-3

- height= 59" or 78.5"



**SPRING 3**

27.5" WIDE SB-3

- standard height= 70.75"  
- #3 grommets in corners



**SPRING 4**

27" WIDE SB-4

- standard height= 60"  
- #3 grommets in corners



**SPRING 5**

31.5" WIDE SB-5

- standard height= 70.75"  
- indoor or outdoor use  
- single or double sided



**SPRING 6**

24.5" WIDE SB-6

- standard height= 63"  
- #3 grommets in corners

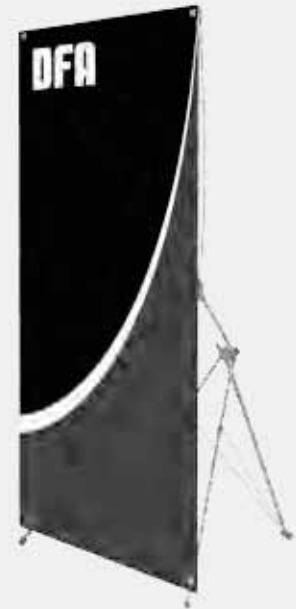

**SPRING 7**

29.5" WIDE SB-7

- variable height= 61.5"-69"  
- #3 grommets in corners



**RETRACTOR 7**

31" WIDE RTRC-2 **NEW**

- standard height= 78.5"



**SCROLLER 1**

28.75" WIDE SC-1   

- variable height= 48" - 72"
- top scrolling mechanism allows for a variety of lengths and styles
- utilizes standard 110v power

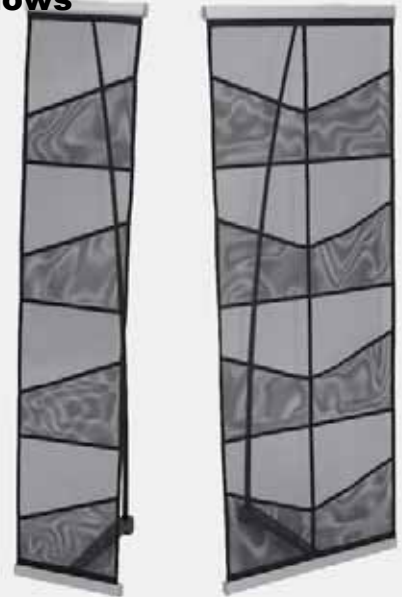

**LR 1 & LR 2**

4 pocket: LR-1   

8 pocket: LR-2

- modular, roll-up mesh design
- assembles in seconds
- holds standard 8.5"x11" literature
- 4 or 8 pocket model
- black with chrome accent

**FOX COUNTERS**

black & natural table top

- lightweight, fabric covered tabletop display
- available in black fabric and natural table top

**RELAY**

black

- fold-away conference easel with bag
- graphic size variable





## Most Excellent Productions Tradeshows



### AERO

AERO



- indoor modular display system
- adjustable heights & angles
- kit includes three 1200mm wide cartridges, four light fittings & bags in an OCH2 molded case
- shown with optional Lumina 200 floodlights, sold separately
- available "à la carte" to create more combinations



kit comes complete as shown above



shown with additional panels and lights

### OBSERVE GRAND

OBSERVE

GRAND

- sleek info center includes sturdy base & adjustable shelf



### OBSERVE PRO

OBSERVE

PRO

- lightweight snap together design
- 12" diameter base
- stylish curved header
- adjustable brochure holder
- accepts 8.5" x 11" graphic and literature
- molded sign clamp will hold an 1/8" thick mounted graphic



416 795 7400 Mike@mxp.to

### HOPUP

- lightweight, heavy duty silver frame
- supports an integrated fabric graphic mural (end caps also available)
- quick & easy setup and pack up
- rolling carry bag included with all units
- 3x3 frame pictured is shown with optional lights (LUM-200-ORL)



# STRAIGHT HOPUP CONFIGURATIONS

## Most Excellent Productions Tradeshows



HOP-2X1-S  
approximate front dimensions:  
60.25" x 31"



HOP-2X2-S  
approximate front dimensions:  
60.25" x 60.25"



HOP-2X2-S  
approximate front dimensions:  
89.25" x 60.25"



HOP-1X3-S  
approximate front dimensions:  
31" x 89.25"



HOP-2X3-S  
approximate front dimensions:  
60.25" x 89.25"



HOP-3X3-S  
approximate front dimensions:  
89.25" x 89.25"

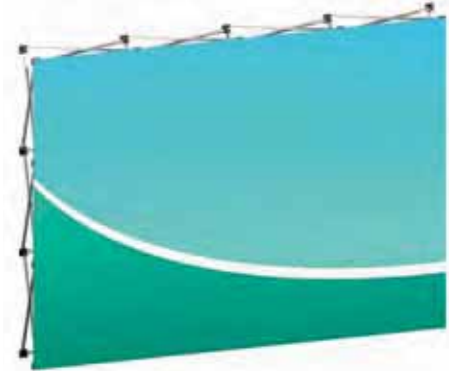

HOP-4X3-S  
approximate front dimensions:  
118.25" x 89.25"

# CURVED HOPUP CONFIGURATIONS

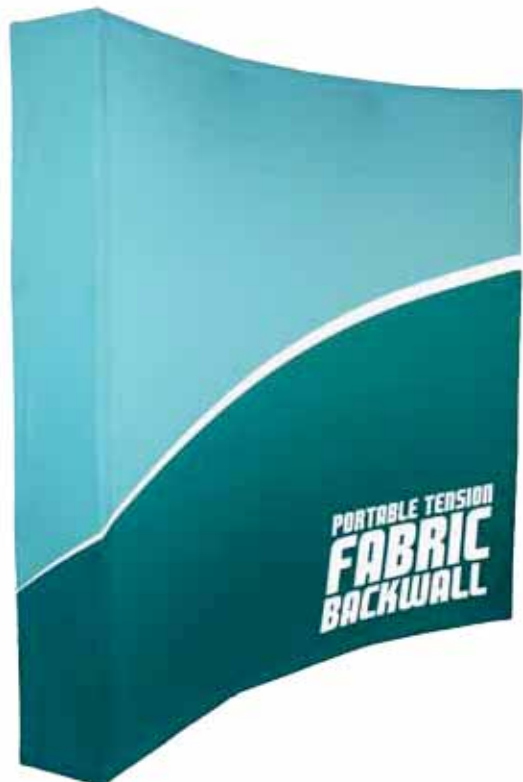

HOP-3X3-C  
approximate front dimensions:  
60.25" x 89.25"



HOP-4X3-C

- lightweight, heavy duty silver frame
- curved frame provides a unique look
- quick & easy setup and pack up
- rolling carry bag included with all units
- 3x3 curved frame pictured is shown with optional end caps

## HOPUP COUNTER

HOP-CT-S



- collapsible display counter
- very portable & lightweight
- includes black internal shelf
- hinged top available in all four laminate finishes
- the perfect complement to your Hopup fabric backwall



416 795 7400 Mike@mxp.to

HOPUP | TENSION FABRIC



**COYOTE**



- fully magnetic popup display system providing a graphic or fabric backwall
- available in a wide range of size configurations (see page 15)

## Most Excellent Productions Tradeshows



### OCP

OCP

- general purpose transit case
- blow molding makes case strong yet lightweight
- built in wheels, handle
- light storage in the lid
- secure reinforced straps help to assure case will remain closed during transport
- recommended for Coyotes



### CASE TO COUNTER CONVERSION

Roll Wrap: OCP-C2C-G

- available in fabric or graphic
- converts OCP to a counter
- polymer counter surface exposed



Stretch Wrap: OCP-SW-G

- stretch fabric pullover
- converts OCP to a counter
- polymer counter surface covered by fabric



### OCP ELITE

OCP-ELITE

- heavy duty shipping and storage case
- lid can be used as a step stool while assembling displays
- access door provides storage when unit is used as a counter
- UPS approved



### CASE TO COUNTER CONVERSION

Roll Wrap: ELITE-C2C-G

- available in fabric or graphic
- converts OCP Elite to a counter
- counter surface exposed



Stretch Wrap: ELITE-SW-G

- stretch fabric pullover
- converts OCP Elite to a counter
- counter surface covered by fabric

### OCS AND OCL

small: OCS  
large: OCL

- blow molded cases for exhibits & graphics
- reliable built-in wheels
- easy-to-grip molded handles
- secure reinforced straps help to assure case will remain closed during transport



416 795 7400 - Mike@mxp.to

### Most Excellent Productions Tradeshows

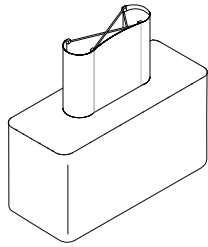

1x1 tabletop  
footprint dimensions:  
30.625"h x 45.5"w x 12.5"d

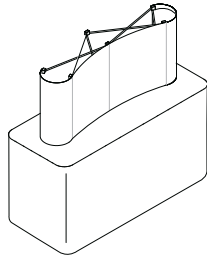

2x1 tabletop  
footprint dimensions:  
30.625"h x 73"w x 19.25"d

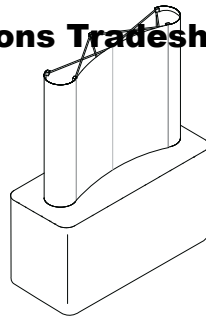

2x2 tabletop kit  
footprint dimensions:  
59.375"h x 73"w x 19.25"d

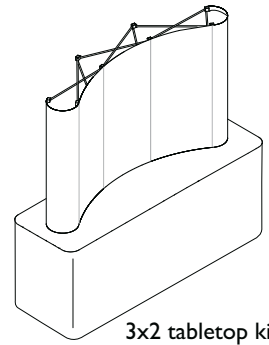

3x2 tabletop kit  
footprint dimensions:  
59.375"h x 97.25"w x 25"d

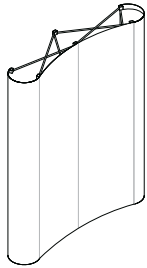

2x3 full height  
slim-line display system  
footprint dimensions:  
87.56"h x 73"w x 19.25"d

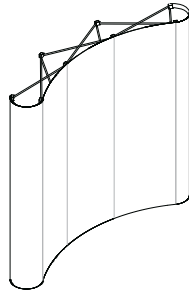

3x3 full height  
standard display system  
footprint dimensions:  
87.56"h x 97.25"w x 25"d

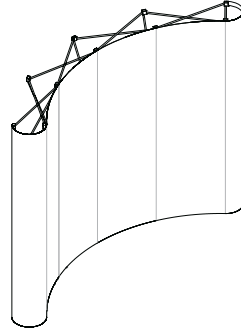

4x3 full height  
standard display system  
footprint dimensions:  
87.56"h x 118"w x 36.5"d

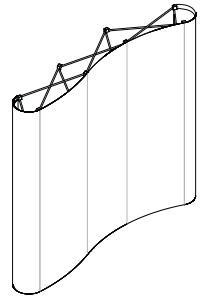

3x3 serpentine  
full height display system  
footprint dimensions:  
87.56"h x 89.5"w x 19.5"d

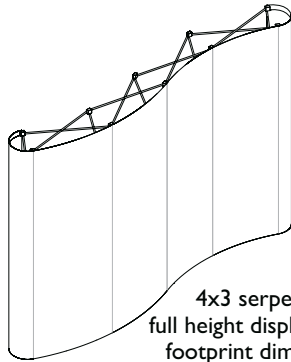

4x3 serpentine  
full height display system  
footprint dimensions:  
87.56"h x 129.5"w x 19.5"d

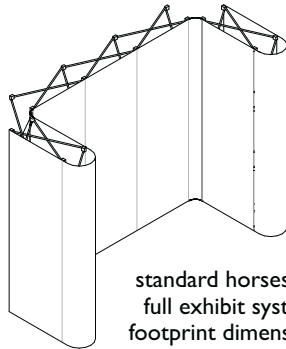

standard horseshoe  
full exhibit system  
footprint dimensions:  
87.56"h x 113"w x 54"d

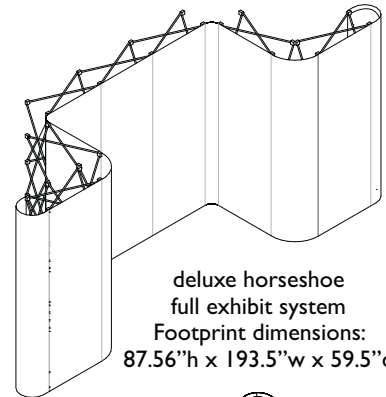

deluxe horseshoe  
full exhibit system  
Footprint dimensions:  
87.56"h x 193.5"w x 59.5"d

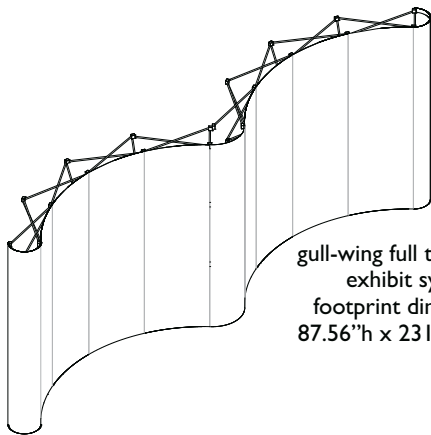

gull-wing full trade show  
exhibit system  
footprint dimensions:  
87.56"h x 231"w x 41"d

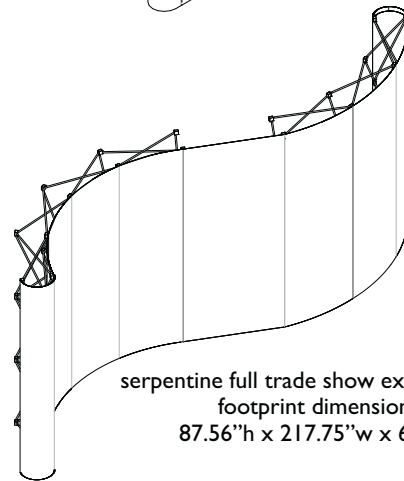

serpentine full trade show exhibit system  
footprint dimensions:  
87.56"h x 217.75"w x 60.5"d

### FABRIC CHOICES

All Coyote popup display systems are available with printed graphic murals or "velcro-friendly" fabric panels of your choice. Actual fabric color may vary slightly.

Regal - smooth exhibit & display fabric

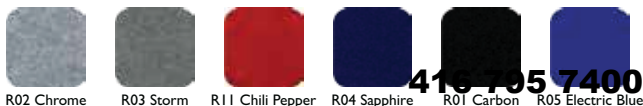

Premier - ribbed exhibit & display fabric

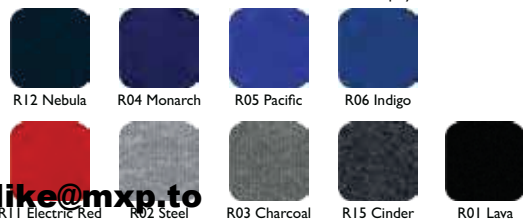

**Most Excellent Productions Tradeshow**

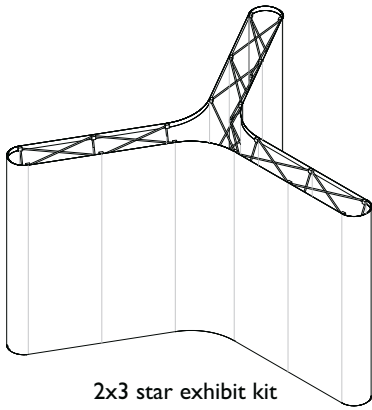

2x3 star exhibit kit

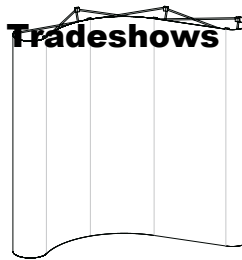
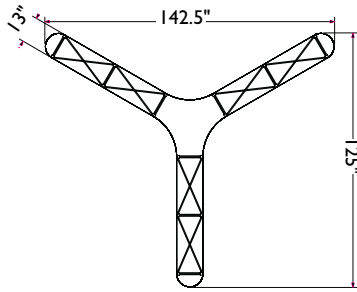

3x3 "L" exhibit kit

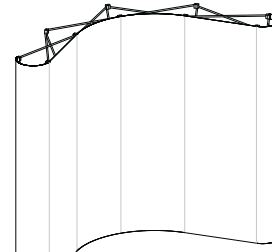
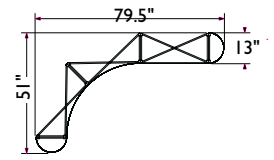

4x3 "L" exhibit kit

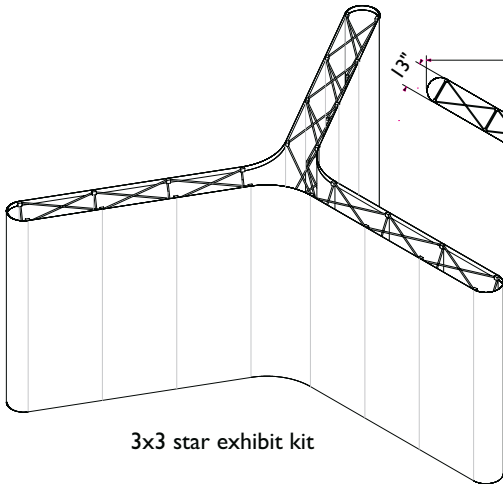
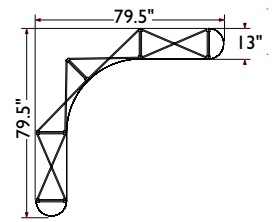

3x3 star exhibit kit

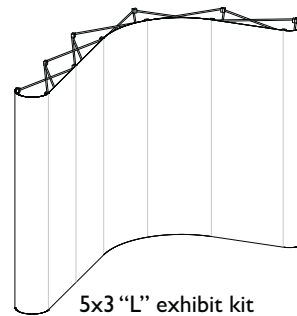
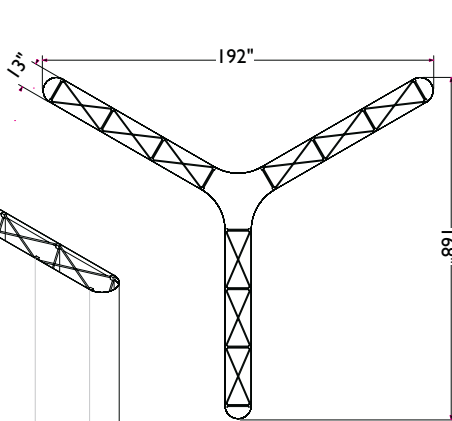

5x3 "L" exhibit kit

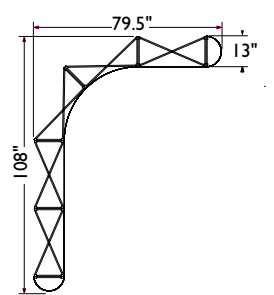

**COYOTE ACCENT KIT**

COY-ACCT-K



- a fresh new look for your Coyote popup
- update your current display with 2 modern wing shapes and 4 extrusions



**COYOTE TOWER**

COY-3-G-TOW

- an unexpected addition to any display; large or small, exhibit or P.O.P
- back-lit panels illuminate your graphics
- coordinates with the look and style of your Coyote popup display



416 795 7400 Mike@mxp.to

the **COYOTE**  
**MINI** popup

Most Excellent Productions Tradeshows



2x2 mini tabletop kit  
footprint dimensions:  
48" h x 53.625" w x 11.75" d



3x2 mini tabletop kit  
footprint dimensions:  
48" h x 74.625" w x 15.75" d

- approx. 20% smaller than standard Coyote tabletops
- entire display rolls up into special storage sleeve which slides into a padded carry case
- kit includes frame, channel bars, panel hangers, carry case, & 2 lights
- add an optional OCS hard case for shipping or extra secure storage

**COYOTE OPTIONS**

Customize your Coyote display with a variety of optional accessories.

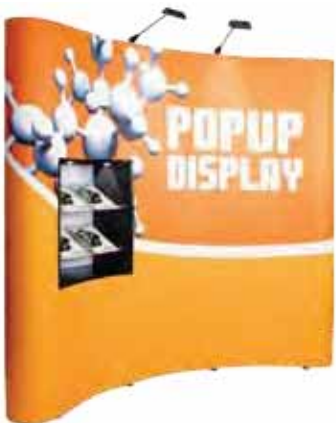
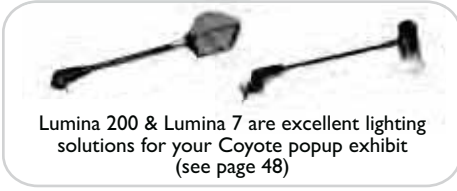

**INTERNAL SHELF KIT**

- presents products or literature
  - comes with 2 clear acrylic shelves to be used horizontally or at 45° angles
  - max capacity per shelf= 15 lbs, max per quadrant= 45 lbs
  - for use with curved frame only
  - **lighting package available**
- (not to be stored with display in OCP)



**MONITOR MOUNT**

- combine print and digital images to strengthen your message
  - fully integrated with straight or curved Coyote systems
  - one panel will be cut to fit the monitor and feet
  - LCD max size= 32"
- (not recommended for panels over 10' x 10' units)

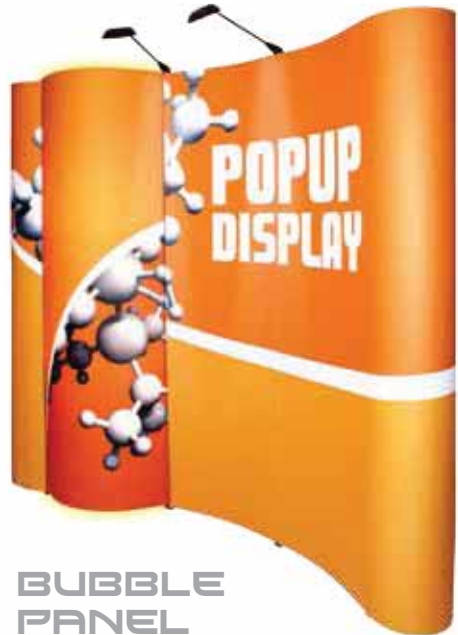

**BUBBLE PANEL**

- forward facing, convex panel
- panel can be fabric, opaque graphic or rear illuminated graphic (light kit sold separately)
- hardware can be stored with display in OCP





**FORMULATE**



- advanced aluminum structure
- rugged plastic molded transit & storage case
- step-by-step instructions
- some kits include: front curved accents, low voltage lighting, tabletops and/or counter, literature pockets, headers and top accents

side mounted tables available on vertically curved Formulate backwalls



416 795 7400 Mike@mxp.to

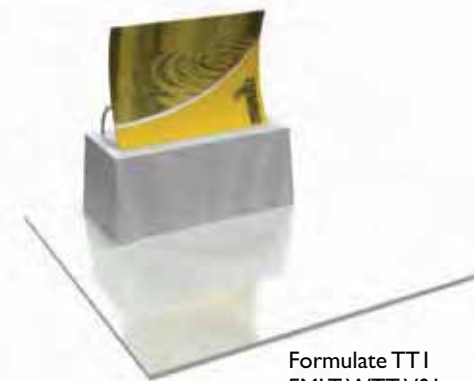

Formulate TT1  
FMLT-WTT-V01

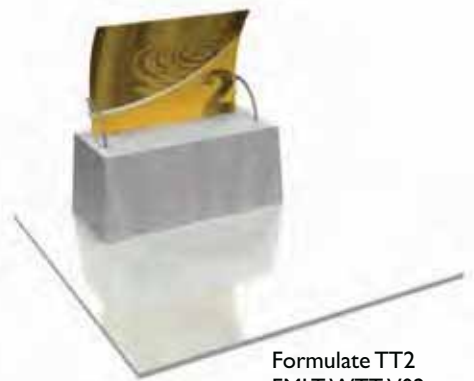

Formulate TT2  
FMLT-WTT-V02

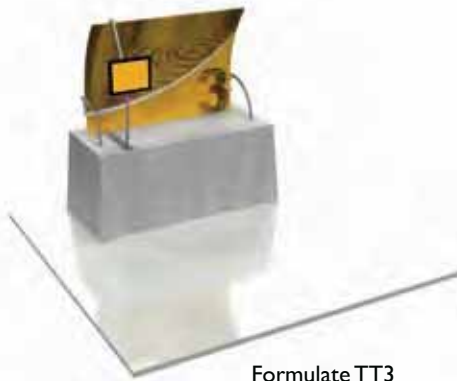

Formulate TT3  
FMLT-WTT-V03

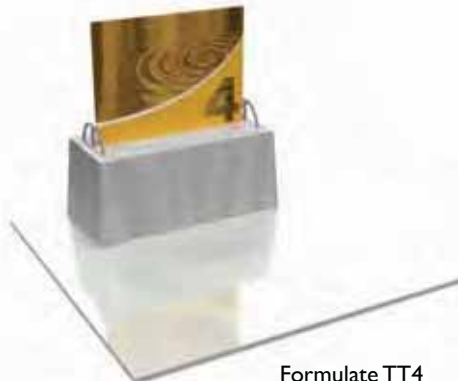

Formulate TT4  
FMLT-WTT-V04

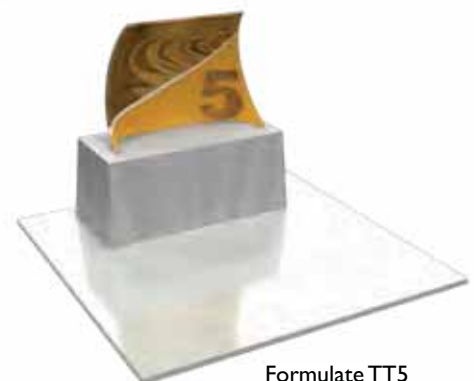

Formulate TT5  
FMLT-WTT-V05

FORMULATE STRAIGHT BACKWALLS



Formulate S1  
FMLT-WS8-01

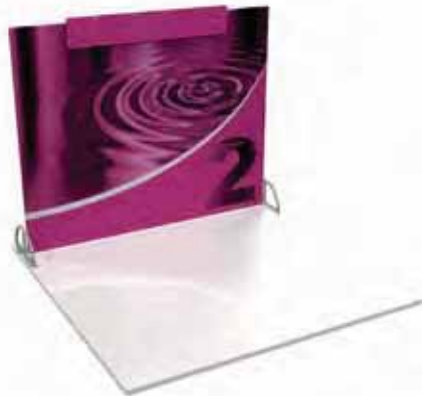

Formulate S2  
FMLT-WS8-02



Formulate S3  
FMLT-WS8-03



Formulate S4  
FMLT-WS8-04

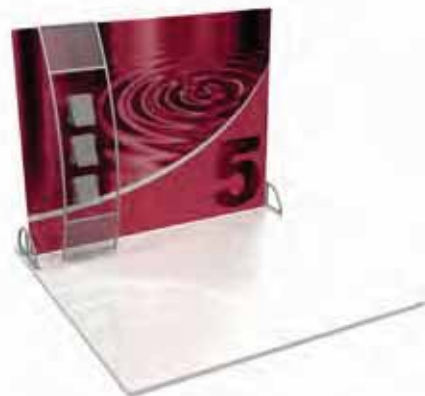

Formulate S5  
FMLT-WS8-05

# FORMULATE HORIZONTALLY CURVED BACKWALLS

Most Excellent Productions Tradeshows



Formulate HC1  
FMLT-WH10-01



Formulate HC2  
FMLT-WH10-02



Formulate HC3  
FMLT-WH10-03

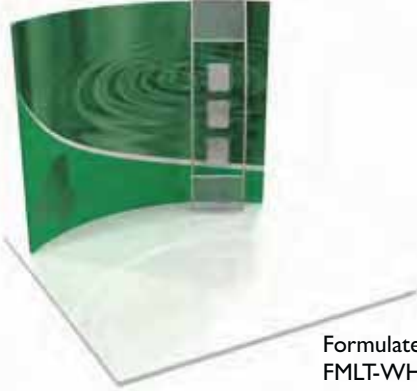

Formulate HC4  
FMLT-WH10-04

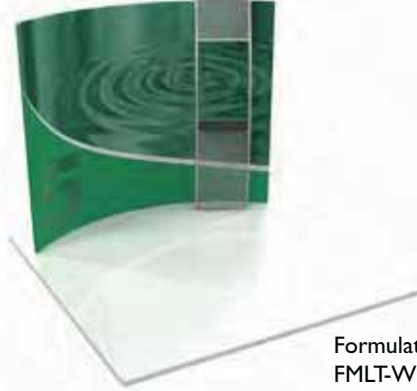

Formulate HC5  
FMLT-WH10-05

# FORMULATE VERTICALLY CURVED BACKWALLS

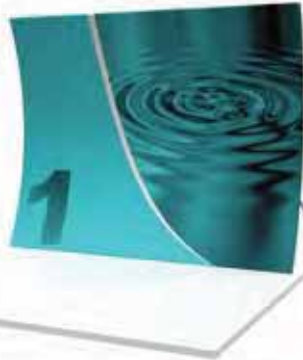

Formulate VC1  
FMLT-WV10-01

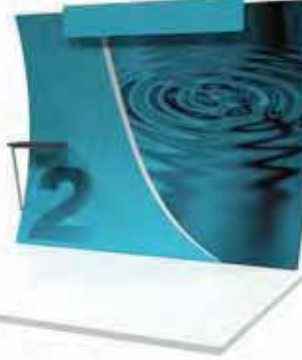

Formulate VC2  
FMLT-WV10-02

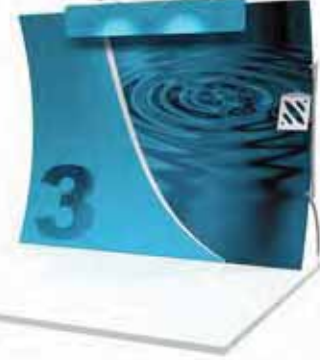

Formulate VC3  
FMLT-WV10-03

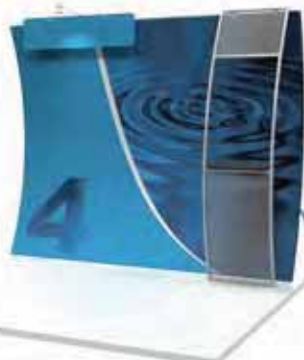

Formulate VC4  
FMLT-WV10-04

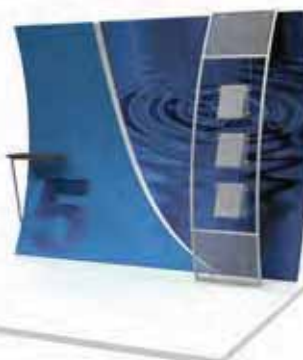

Formulate VC5  
FMLT-WV10-05

FORMULATE | TENSION FABRIC

FORMULATE 8' BACKWALLS

Most Excellent Productions Tradeshows



Formulate 8S  
FMLT-WS8-01



Formulate 8H  
FMLT-WH8-01

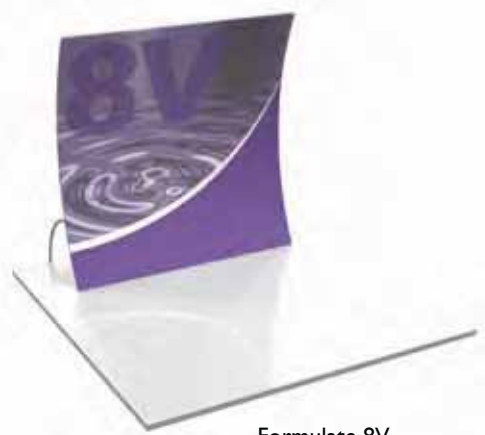

Formulate 8V  
FMLT-WV8-01

FORMULATE 20' BACKWALLS

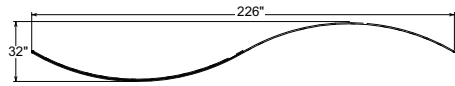

Formulate 20S  
FMLT-WS20-01

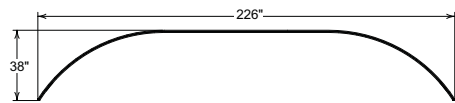

Formulate 20H  
FMLT-WH20-01

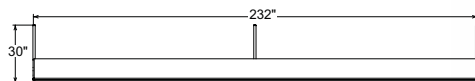

Formulate 20V  
FMLT-WC20-01



Most Excellent Productions Tradeshows

RING

- 8' diam. x 3'h
- 10'9" diam. x 4'h
- 12' diam. x 4'h
- 14' diam. x 4'h
- 16' diam. x 4'h
- 18' diam. x 4'h
- 20' diam. x 4'h

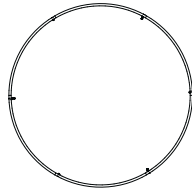

TAPERED RING

- 8' diam. x 3'h
- 10'9" diam. x 4'h
- 12' diam. x 4'h
- 14' diam. x 4'h
- 16' diam. x 4'h
- 18' diam. x 4'h
- 20' diam. x 4'h

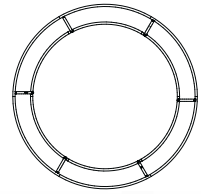

FOUR SIDED

- 8'w x 3'h
- 8'10"w x 4'h
- 12'w x 4'h
- 14'w x 4'h
- 16'w x 4'h
- 18'w x 4'h
- 20'w x 4'h

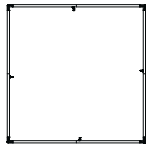

FOUR SIDED

- 10'w x 4'h
- 12'w x 4'h
- 16'w x 5'h
- 20'w x 5'h

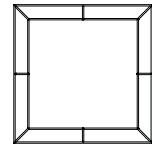

CONCAVE FOUR SIDED

- 8'10"w x 3'h
- 8'10"w x 4'h
- 12'w x 4'h
- 14'w x 4'h
- 16'w x 4'h
- 18'w x 4'h
- 20'w x 4'h

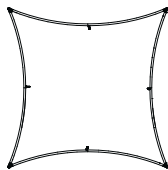

THREE SIDED

- 6'w x 3'h
- 10'9"w x 4'h
- 12'w x 4'h
- 14'w x 4'h
- 16'w x 4'h
- 18'w x 4'h
- 20'w x 4'h

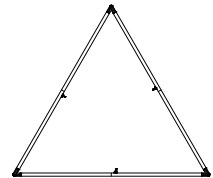

TAPERED THREE SIDED

Most Excellent Productions Tradeshows

CONVEX THREE SIDED

10'w x 4'h  
 12'w x 4'h  
 16'w x 5'h  
 20'w x 5'

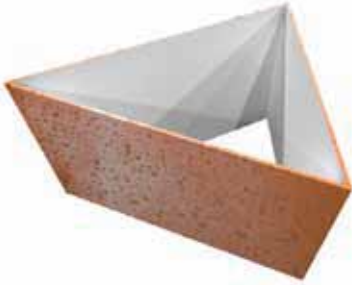
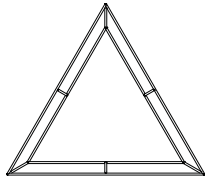

8'9''w x 3'h  
 8'9''w x 4'h  
 12'w x 4'h  
 20'w x 5'h

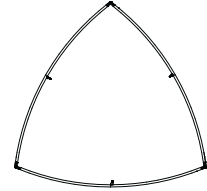

PINWHEEL

8'9''w x 3'h  
 8'9''w x 4'h  
 12'w x 4'h  
 16'w x 4'h  
 20'w x 4'h



RECTANGLE

12'l x 6'w x 4'h  
 16'l x 8'w x 5'h  
 20'l x 10'w x 5'h

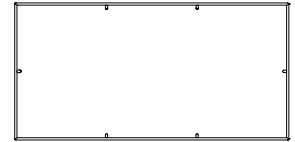

FOOTBALL

12'l x 4'h  
 15'l x 4'h  
 20'l x 5'h

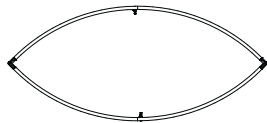

FOUR SIDED PYRAMID

10'w x 5'h  
 12'w x 6'h  
 16'w x 8'h  
 20'w x 10'h

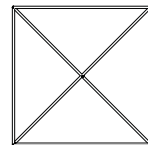

Most Excellent Productions Tradeshows

- 10'w x 5'h
- 12'w x 6'h
- 16'w x 8'h
- 20'w x 10'h

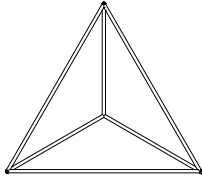

10'w x 4'h

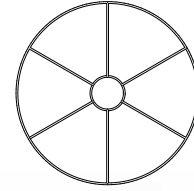

SQUARE FUNNEL

10'w x 4'h

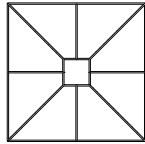

CONE

- 10'w x 5'h
- 12'w x 6'h
- 16'w x 8'h
- 20'w x 10'h

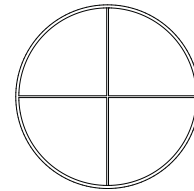

CURVE

- 8'w x 3'h
- 8'9''w x 4'h
- 12'w x 4'h
- 15'w x 4'h
- 16'w x 4'h
- 20'w x 4'h
- 20'w x 6'h



DISC



- 8' diameter
- 10'9'' diameter
- 12' diameter
- 14' diameter
- 16' diameter
- 18' diameter
- 20' diameter

PANEL

- 8'w x 3'h
- 8'9''w x 4'h
- 12'w x 4'h
- 15'w x 4'h
- 16'w x 4'h
- 20'w x 4'h
- 20'w x 6'h



S-CURVE



- 8'w x 3'h
- 17'w x 4'h
- 12'w x 4'h
- 12'w x 6'h
- 16'w x 4'h
- 16'w x 6'h
- 20'w x 6'h

**TABLE THROW**

**Most Excellent Productions Tradeshows**

- 4 foot full: TBL-T-4-F
- 4 foot economy: TBL-T-4-E
- 6 foot full: TBL-T-6-F
- 6 foot economy: TBL-T-6-E
- 8 foot full: TBL-T-8-F
- 8 foot economy: TBL-T-8-E

- complete your presentation with a dye-sub printed table throw
- lends a polished appearance to any display
- maximize your advertising with additional space to display your message



shown with Horizon Standard tabletop folding panel display (see page 22)



4' table throws now available for smaller tables



**TABLE RUNNERS**

- 24" full: TBL-R-24-F
- 24" economy: TBL-R-24-E
- 30" full: TBL-R-30-F
- 30" economy: TBL-R-30-E
- 60" full: TBL-R-60-F
- 60" economy: TBL-R-60-E

- accent your solid colored table throw with a full color printed runner
- available in 3 widths



**CONVERTIBLE TABLE THROW**

- convertible full: TBL-T-FC
- convertible economy: TBL-T-EC

- converts quickly and easily to fit both a 6' and 8' table
- Velcro tabs make conversion simple





Most Excellent Productions Tradeshows

**EFEX** Simple & Effective

MADE **in** CANADA

FOLDING DISPLAY PANELS



**Models & Accessories**

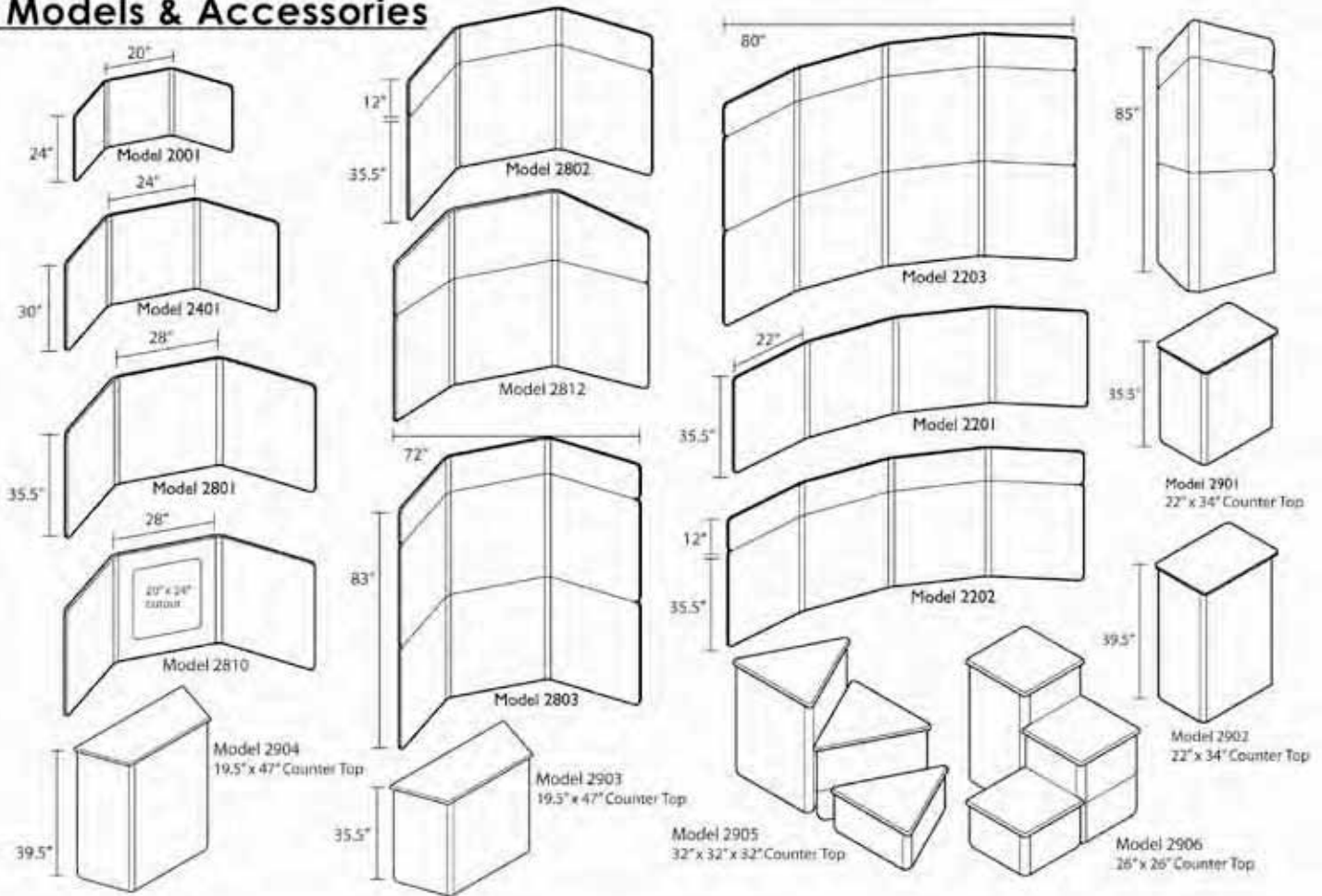

**FABRIC CHOICES**

All Coyote popup display systems are available with printed graphic murals or "velcro-friendly" fabric panels of your choice. Actual fabric color may vary slightly.

Regal - smooth exhibit & display fabric



Premier - ribbed exhibit & display fabric

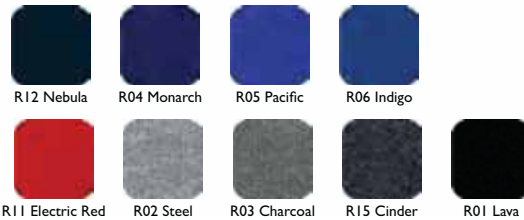

416 795 7400

Mike@mxp.to

## HORIZON 6

### Most Excellent Productions Tradeshows

WEIGHS 22 LBS HZ-6



- main panel sizes approximately= 2' x 3'
- custom sized panel displays are available
- shown with optional detachable graphics
- available in a variety of fabric color options (page 23)



## TABLETOP | STANDARD

WEIGHS 12 LBS HZ-TT-S



- 3 panels plus a header
- shown with optional detachable graphics
- available in a variety of fabric color options (page 23)

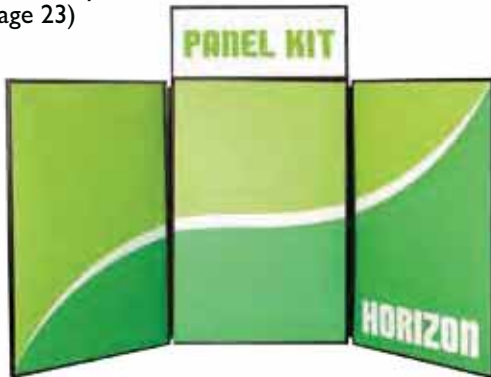

## TABLETOP | DELUXE MASTER

WEIGHS 13.5 LBS HZ-TT-M



- detachable graphics available
- available in a variety of fabric color options (page 23)



## HORIZON 8

WEIGHS 31 LBS HZ-8

- 8 panel kit
- complete backwall with 2 headers
- detachable graphics available
- available in a variety of fabric color options (page 23)



416 795 7400 Mike@mxp.to

# HERO

## Most Excellent Productions Tradeshows

- durable premium seamless exhibit panel kits
- convenience of folding panels with elegant, seamless panel construction
- concealed hinges
- unique 2" radius curved ends lend a polished appearance
- full height units can also be used as two tabletop units
- available in a variety of fabric color options
- shown with optional detachable graphics



### OCH CASE OCH



shown with optional graphics  
HERO H16

FOLDING DISPLAY PANELS

**3'11" HIGH**

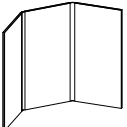
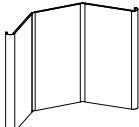
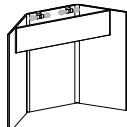
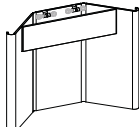
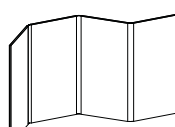
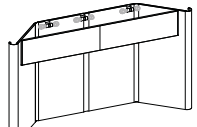
					
<b>HERO H02-1</b> tabletop display	<b>HERO H02-2</b> tabletop display with curved endcaps	<b>HERO H03</b> tabletop display with backlit header	<b>HERO H04</b> tabletop display with backlit header and curved endcaps	<b>HERO H05</b> tabletop display	<b>HERO H08</b> tabletop display with backlit header and curved endcaps

**7'10" HIGH**

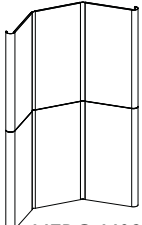
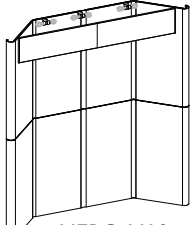
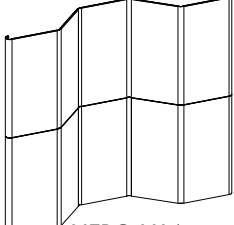
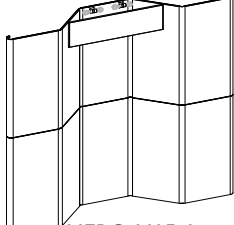
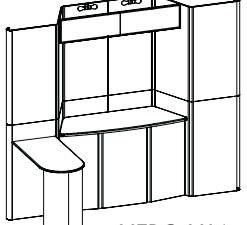
				
<b>HERO H09</b> full height exhibit with curved endcaps	<b>HERO H10</b> full height exhibit with curved endcaps and backlit header	<b>HERO H14</b> full height exhibit with curved endcaps	<b>HERO H15-1</b> full height exhibit with curved endcaps & backlit header	<b>HERO H16</b> 10' full height exhibit kit with curved end caps, backlit header & peninsula

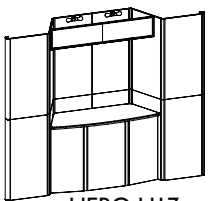
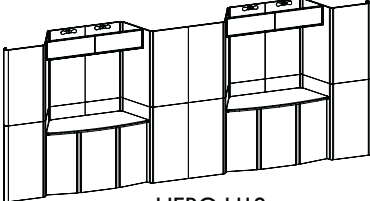
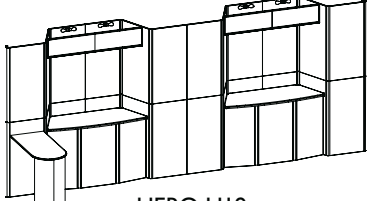
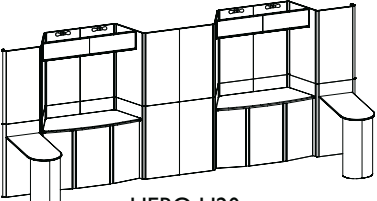
			
<b>HERO H17</b> 10' full height exhibit kit with curved end caps & backlit header	<b>HERO H18</b> 20' full height exhibit kit with curved end caps & backlit header	<b>HERO H19</b> 20' full height exhibit kit with curved end caps, backlit header & one peninsula	<b>HERO H20</b> 20' full height exhibit kit with curved end caps, backlit header & two peninsulas

### FABRIC CHOICES

All Hero & Horizon folding display panels are available with detachable graphic panels or "velcro-friendly" fabric panels of your choice. Actual fabric color may vary slightly.

Regal - smooth exhibit & display fabric

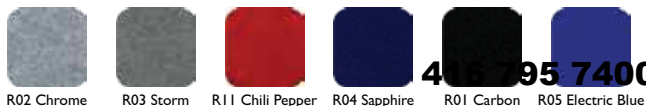

Premier - ribbed exhibit & display fabric

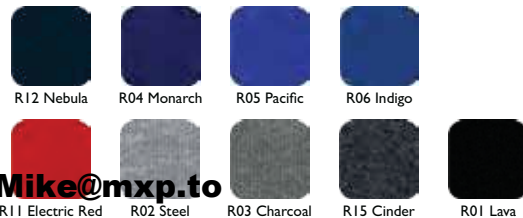

408-957-7400

Mike@mxp.to

# VOYAGER Most Excellent Productions Tradeshows

## 24 SERIES

The Voyager has been specially developed as a briefcase style table top display and is a great choice for promotions on the go. It has a rigid, thermo formed ABS exterior and a black, Velcro compatible fabric interior.

All units are shown with Velcro detachable graphics. Header options shown with V-2 and V-3 models are also available for V-1.



VY-3

VY-2

VY-1

VY 3 WEIGHS 8.25 LBS

VY 2 WEIGHS 6.5 LBS

VY 1 WEIGHS 5 LBS

FOLDING DISPLAY PANELS

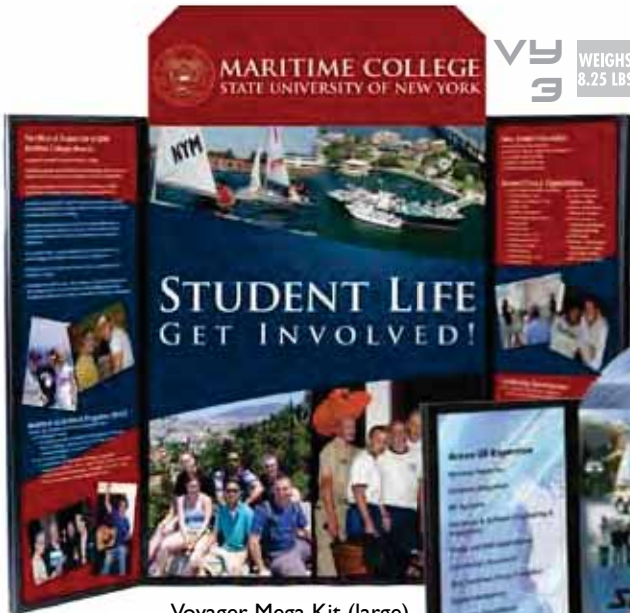

Voyager Mega Kit (large)  
open dimensions: 32”h x 48”w  
closed dimensions: 32”h x 24”w



Voyager Maxi Kit (medium)  
open dimensions: 24”h x 48”w  
closed dimensions: 24”h x 24”w



Voyager Mini Kit (small)  
open dimensions: 18”h x 48”w  
closed dimensions: 18”h x 24”h



### VOYAGER CARRY BAG

- Voyager Mini bag: VY-1-BG
- Voyager Maxi bag: VY-2-BG
- Voyager Mega bag: VY-3-BG
- Voyager Supreme bag: VY-4-BG
- Voyager Monster bag: VY-5-BG



### CUSTOMIZE

Brand the exterior of your Voyager to match your company and/or product colors to maximize your marketing efforts.

Minimum 12 units, call for details.

**32 SERIES**

All Voyager systems have a limited Lifetime Warranty. Internal graphics can remain on the Voyager during transport. Header options should be removed for transport and storage.



Voyager Monster kit (xx-large)  
open dimensions: 32”h x 64”w  
closed dimensions: 32”h x 32”w

Detachable graphics allow for easy changes! Extra graphics can be stored in the display case and packed away for easy storage.



Voyager Supreme kit (x-large)  
open dimensions: 24”h x 64”w  
closed dimensions: 24”h x 32”w



Carry your Voyager hands-free by adding a water-resistant canvas carry bag with shoulder strap. Stores header, extra graphics & literature.



- your choice of four standard patterns, custom graphic option also available
- countoured design creates a refined, substantial look
- quick & simple assembly
- wire management option available
- comes with an OCH shipping & transport case

PERSONALIZE YOUR V-CLASS

front, back & top are available in your choice of finishes

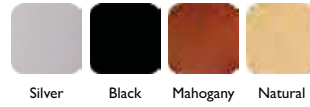

sides are available in your choice of printed patterns

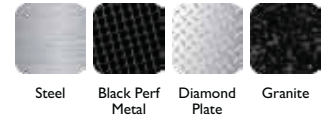

counter tops are available in your choice of shapes

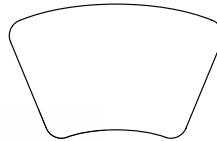

Quad

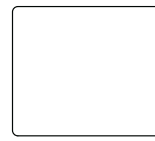

Square

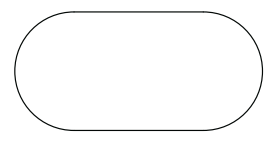

Racetrack



repositionable shelves adjust to your storage needs

CAMPAIGN

CP-BI

- quick assembly
- strong & easy to clean plastic parts



HOPUP COUNTER

HOP-CT-S



- collapsible display counter
- very portable & lightweight
- includes black internal shelf
- hinged top available in all four laminate finishes



counter folds up compact



hinged top makes unit



internal shelving for hideaway storage

# Most Excellent Productions Tradeshows

SYMPHONY COUNTER



- unique, sleek design lends an attractive element to your tradeshow or POP display
- quick set-up, easy assembly
- modern colors draw attention to your booth
- a perfect complement to your Linear display



Oval Grand  
SYM-OV-GRND

counter stretch skirts are available in the following colors



tops are available in your choice of finishes

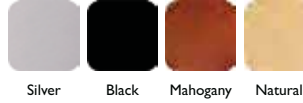

Oval  
SYM-OV



Quad  
SYM-QD



Rectangle  
SYM-RCT

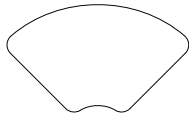

Quad Grand  
SYM-QD-GRND

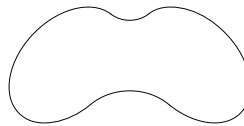

Oval Double Grand  
SYM-OV-DBL-GRND

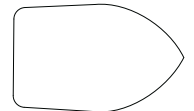

Bullet  
SYM-BLLT

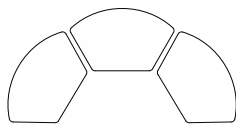

3 Quad Kit  
SYM-QD-3

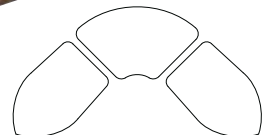

Corner Kit  
SYM-CRNR

LINEAR COUNTER

Most Excellent Productions Tradeshows

- coordinates with the Linear hybrid modular display line
- 3 graphic panels available to display your custom graphics
- quick & easy to assemble, tool included
- fits in our OCH shipping and transport case
- aluminum design is sturdy and stable



tops are available in your choice of finishes



open back allows for hidden storage



user-friendly leg connections



simple & secure cam lock connections

LINEAR MONITOR KIOSK KITS

- hybrid modular display systems
- each kit comes standard with a 2-section upright post, decorative cap, LCD mounting bracket, PC shelf, & all necessary mounting hardware



tops are available in your choice of finishes



Kit 1  
LN-MK-1



Kit 2  
LN-MK-2



Kit 3  
LN-MK-3



Kit 4  
LN-MK-4



Kit 5  
LN-MK-5

416 795 7400 Mike@mxp.to



VECTOR FRAMES

Most Excellent Productions Tradeshows

- easy to set up and break down
- clean, simple, sophisticated look
- vibrant tension fabric graphic
- extrusion based
- single or double sided
- heavy duty silver frame and feet



silicone tubing makes for simple graphic installation



AVAILABLE SIZES:



01 Rectangle  
VF-R-01



02 Rectangle  
VF-R-02



03 Rectangle  
VF-R-03



04 Rectangle  
VF-R-04



01 Square  
VF-S-01



02 Square  
VF-S-02



03 Square  
VF-S-03



04 Square  
VF-S-04

416 795 7400 Mike@mxp.to

# LINEAR

Most Excellent Productions Tradeshows

Linear provides a modern & dynamic enhancement to your marketing message. The range is simple & lightweight, yet provides the strength & versatility to meet the needs of today's demanding exhibit or event requirements.



## LINEAR TABLETOP KITS

- simple & lightweight
- cost effective
- takes minutes to assemble
- advanced aluminum structure
- stylish 50 watt low voltage
- rugged plastic molded transit & storage case
- step-by-step setup instructions
- fully customizable, high quality digitally printed graphic options available



## LINEAR STANDARD KITS

- simply stylish
- slim structure emphasizes the primary focus
- takes minutes to assemble
- advanced aluminum structure
- stylish 50 watt low voltage
- rugged plastic molded transit & storage case
- step-by-step setup instructions
- options include: LCD mounts, tabletops & counters, literature pockets, larger freight cases
- fully customizable, high quality digitally printed graphic options available



## LINEAR PRO KITS

- hybrid modular display systems
- quick set up
- stylish wing design options
- extrusion structure is complemented by a fabric canopy
- advanced aluminum structure
- stylish 50 watt low voltage
- rugged plastic molded transit & storage case
- step-by-step setup instructions
- options include: LCD mounts, tabletops & counters, literature pockets, larger freight cases
- fully customizable, high quality digitally printed graphic options available



## LINEAR BOLD KITS

- hybrid modular display systems
- quick set up
- stylish wing design options
- broad structure creates a dynamic & imposing framework
- advanced aluminum structure
- stylish 50 watt low voltage
- rugged plastic molded transit & storage case
- step-by-step setup instructions
- options include: LCD mounts, tabletops & counters, literature pockets, larger freight cases
- fully customizable, high quality digitally printed graphic options available

416 795 7400 [Mike@nrxp.to](mailto:Mike@nrxp.to)

- hybrid modular display systems
- quick set up
- stylish wing design options



Kit AA  
LN-K-TT-AA



Kit BB  
LN-K-TT-BB



Kit CC  
LN-K-TT-CC



Kit DD  
LN-K-TT-DD



Kit EE  
LN-K-TT-EE



Kit FF  
LN-K-TT-FF



Kit GG  
LN-K-TT-GG



Kit HH  
LN-K-TT-HH

416 795 7400 Mike@mxp.to

# LINEAR

Most Excellent Productions Tradeshows  
comes in durable molded cases

your choice of table finishes



Silver Black Mahogany Natural



## LINEAR STANDARD



Kit 01  
LN-K-3P-01

your choice of Lumina lights (2 lights per 10', 4 lights per 20')



Lumina 1 Lumina 3 Lumina 5 Lumina 6 Lumina 8



Kit 02  
LN-K-3P-02



Kit 03  
LN-K-3P-03

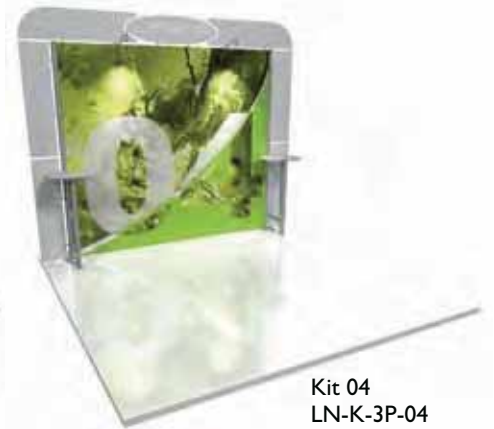

Kit 04  
LN-K-3P-04



Kit 05  
LN-K-3P-05



Kit 06  
LN-K-3P-06

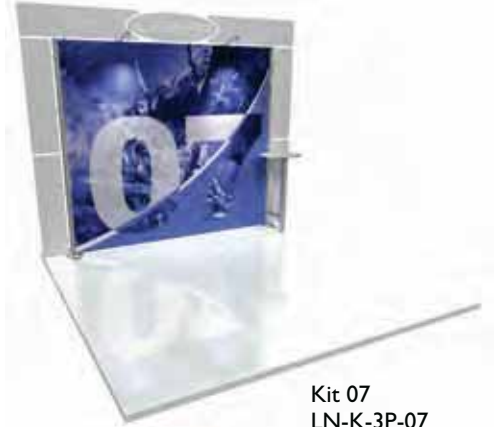

Kit 07  
LN-K-3P-07



Kit 08  
LN-K-3P-08



Kit 09

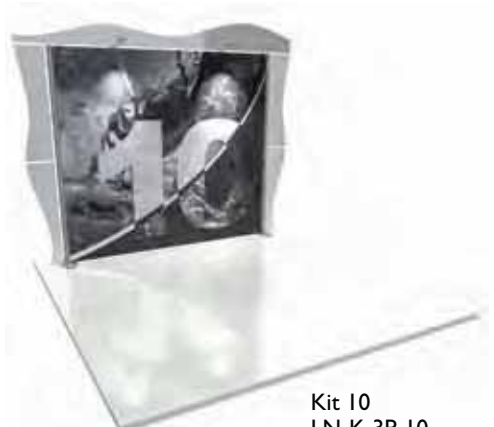

Kit 10  
LN-K-3P-10

416 795 7400 Mike@mcp.to

LINEAR | 10' X 10'

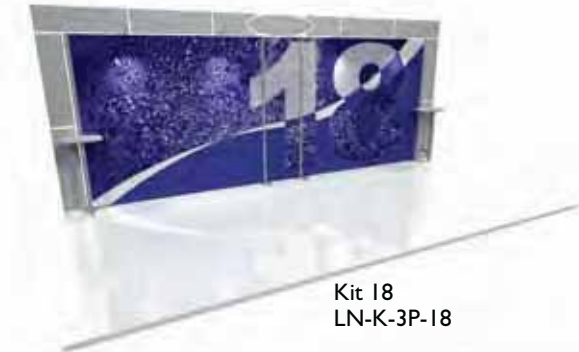
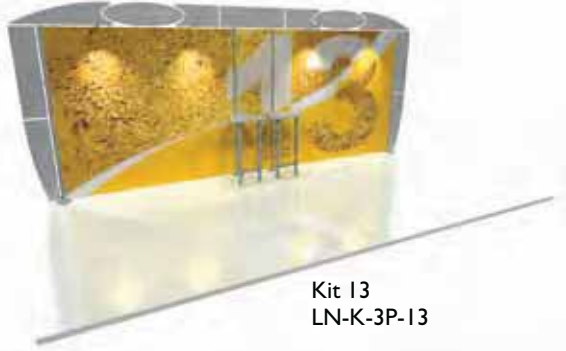

# LINEAR

Most Excellent Productions Tradeshows

## LINEAR PRO 10' X 10' KITS



Kit 21  
LN-K-3P-21

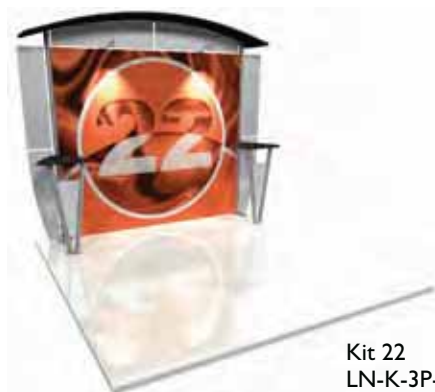

Kit 22  
LN-K-3P-22

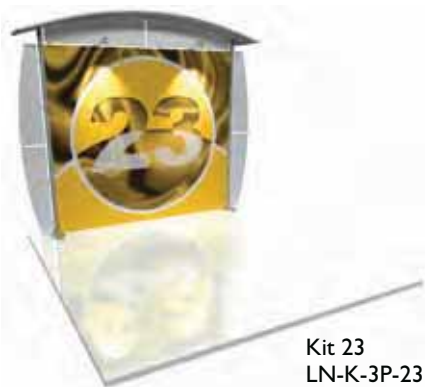

Kit 23  
LN-K-3P-23



Kit 24  
LN-K-3P-24



Kit 25  
LN-K-3P-25

## 10' X 20' KITS



Kit 26  
LN-K-3P-26



Kit 27  
LN-K-3P-27

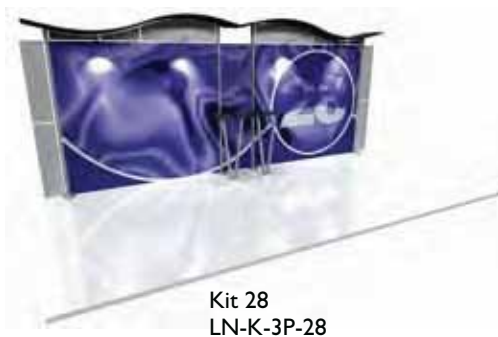

Kit 28  
LN-K-3P-28



Kit 29  
LN-K-3P-29

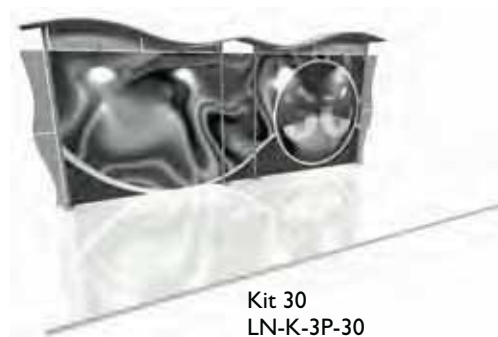

Kit 30  
LN-K-3P-30

LINEAR PRO | 10' X 10' & 10' X 20'

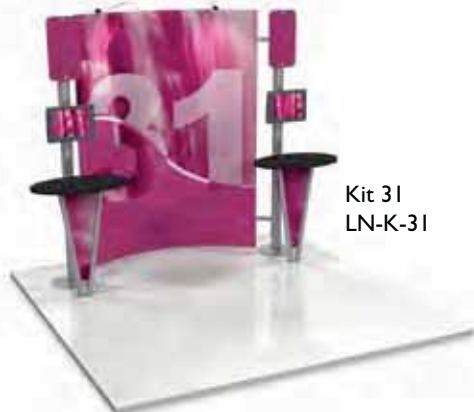

Kit 31  
LN-K-31



Kit 32  
LN-K-32

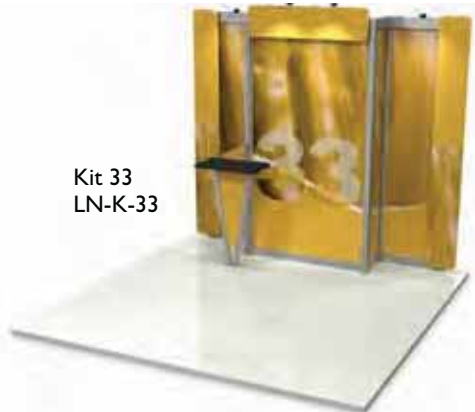

Kit 33  
LN-K-33



Kit 34  
LN-K-34



Kit 35  
LN-K-35



Kit 36  
LN-K-36



Kit 37  
LN-K-37



Kit 38  
LN-K-38

Most Excellent Productions Tradeshows



ATLANTIS 03

10'x10' KIT OR-K-ATL3

- truss backwalls offer a unique look
- shelving and monitor brackets allow for professional looking displays
- no tools necessary
- simple twist-lock construction
- new sturdy feet make these stand-alone backwalls possible





**Most Excellent Productions Tradeshows**

**ATLANTIS 01**  
OR-K-ATL1



**ATLANTIS 02**  
OR-K-ATL2



**ATLANTIS 04**  
OR-K-ATL4

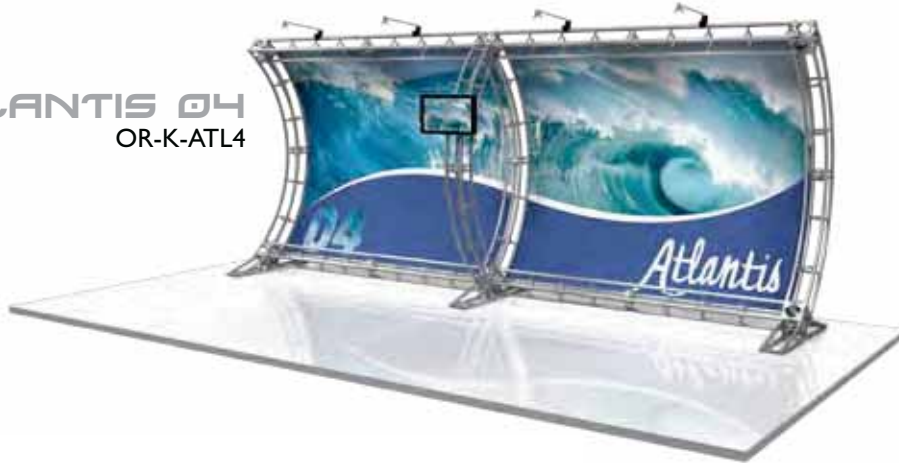

**ATLANTIS 05**  
OR-K-ATL5

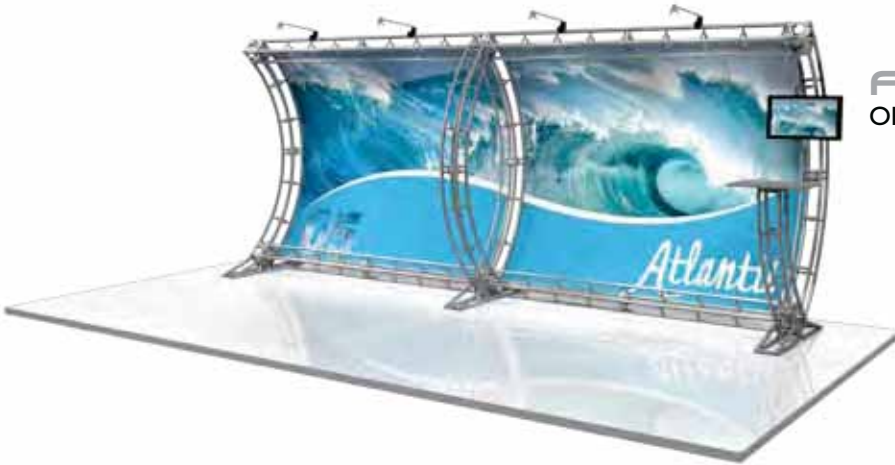

**ATLANTIS 06**  
OR-K-ATL6

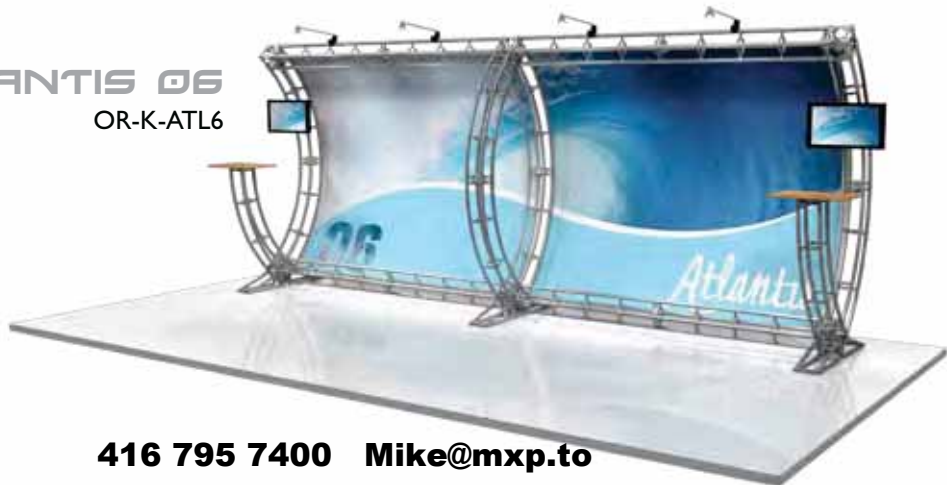

**HERCULES**

**Most Excellent Productions Tradeshows**

- truss backwalls offer a unique look
- shelving and monitor brackets allow for professional looking displays
- no tools necessary
- simple twist-lock construction
- new sturdy feet make these stand-alone backwalls possible



tables & shelves are available in your choice of finishes

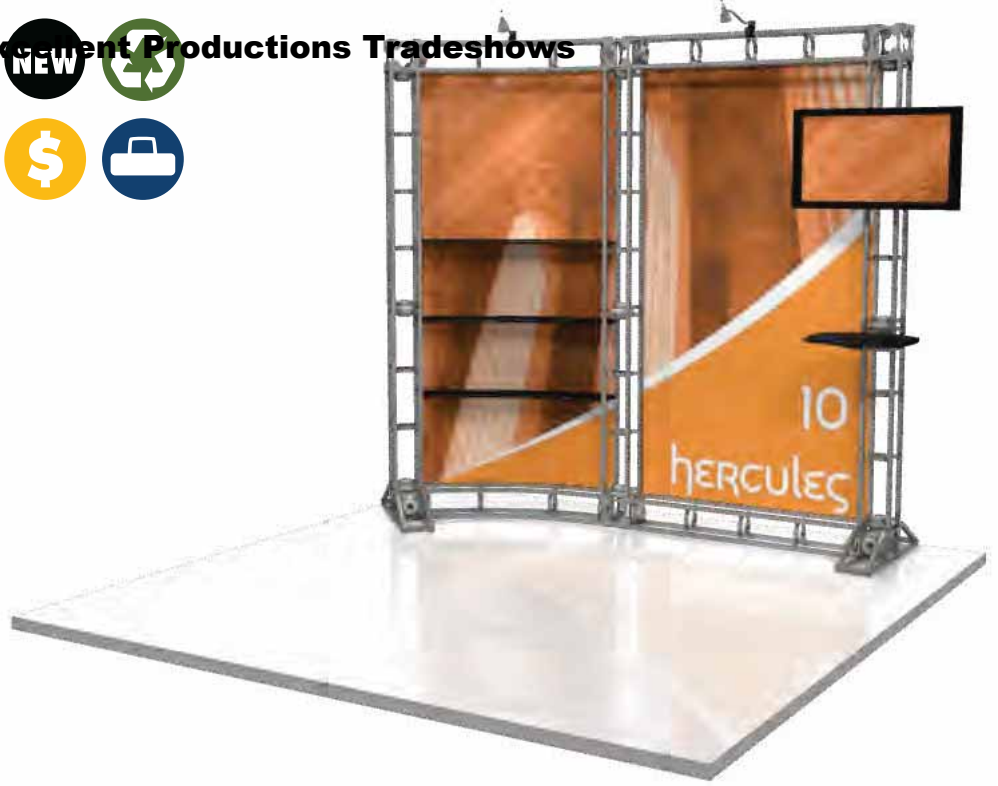

Kit 01  
OR-K-HC01



Kit 02  
OR-K-HC02



Kit 03  
OR-K-HC03



Kit 04  
OR-K-HC04



Kit 05  
OR-K-HC05

# Most Excellent Productions Tradeshows

Kit 06  
OR-K-HC06



Kit 07  
OR-K-HC07



Kit 08  
OR-K-HC08

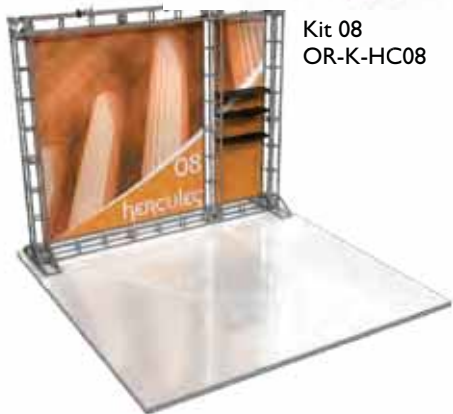

Kit 9  
OR-K-HC09

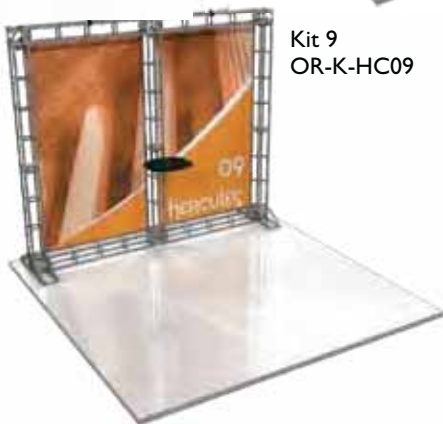

Kit 10  
OR-K-HC10

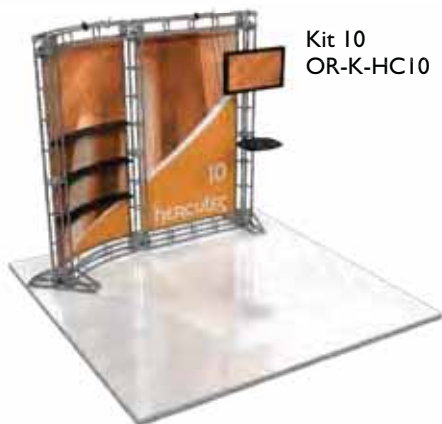

Kit 11  
OR-K-HC11



Kit 12  
OR-K-HC12



Kit 13  
OR-K-HC13



Kit 14  
OR-K-HC14



Kit 15  
OR-K-HC15



416 795 7400 Mike@mxp.to



# Most Excellent Productions Tradeshows

ORBITAL EXPRESS | 10' X 10' KITS



**SIRIUS**

10'x10'  
KIT

OR-K-SR1



The Orbital Express Truss System requires **NO TOOLS** for set up! Installation couldn't be easier, simply twist & lock. The specially designed connectors are simple to use, strong & secure. Our truss kits can be reconfigured in multiple ways using the same parts. Have a different exhibit for each show! We offer more than 40 professionally designed "off the shelf" kits for a variety of booth sizes and configurations. Each kit comes complete with all the parts, fixtures and fittings you need to create a successful exhibit, including (depending on the kit) low voltage spotlights and adjustable tabletops.

All Orbital Express Truss kits are both an economical and eco-friendly exhibit choice. All kits include appropriate shipping cases.

# ARA

10'x10' KIT OR-K-AA1



## Most Excellent Productions Tradeshows

# VELA-2

10'x10' KIT OR-K-VLI-2

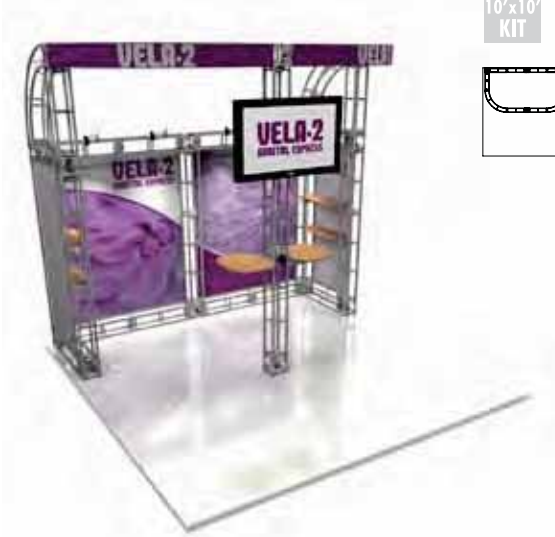
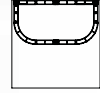

# CETUS

10'x10' KIT OR-K-CT1



# LYRA

10'x10' KIT OR-K-LY1 corner kit

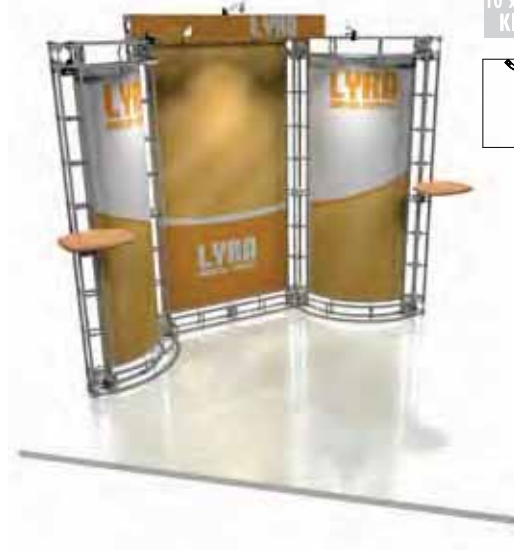
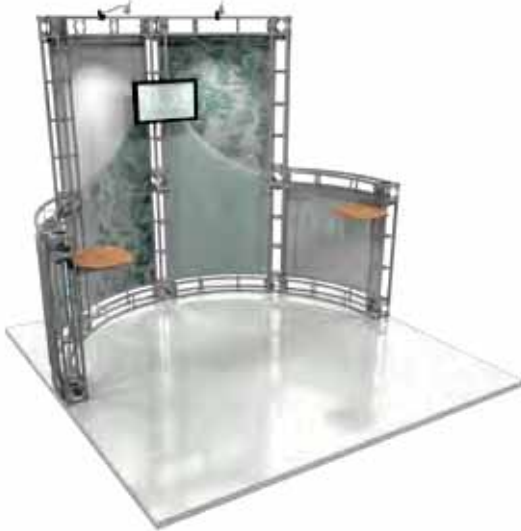
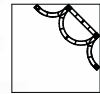

# CARINA

10'x10' KIT OR-K-CR1



# CASTOR

10'x10' KIT OR-K-CS1

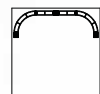

ORBITAL EXPRESS | 10' X 10' KITS

### CYGNUS

## Most Excellent Productions Tradeshows

### PLUTO

10'x10' KIT OR-K-SYGI corner kit

10'x10' KIT OR-K-PLI

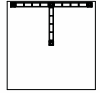

### MERCURY

### LYNX

10'x10' KIT OR-K-MFI

10'x10' KIT OR-K-LXI

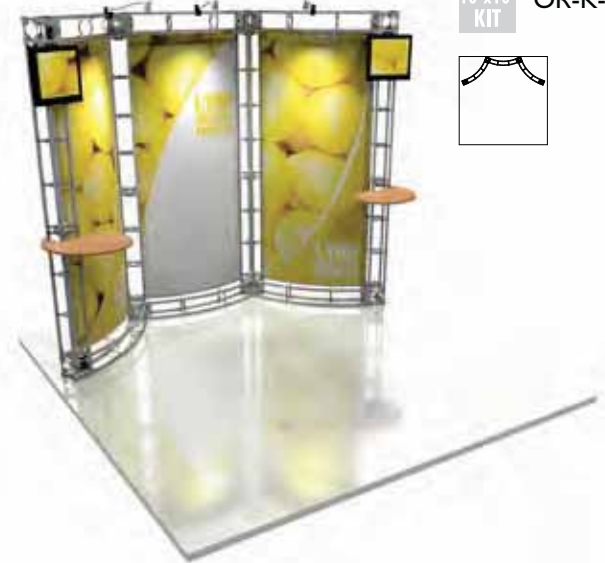
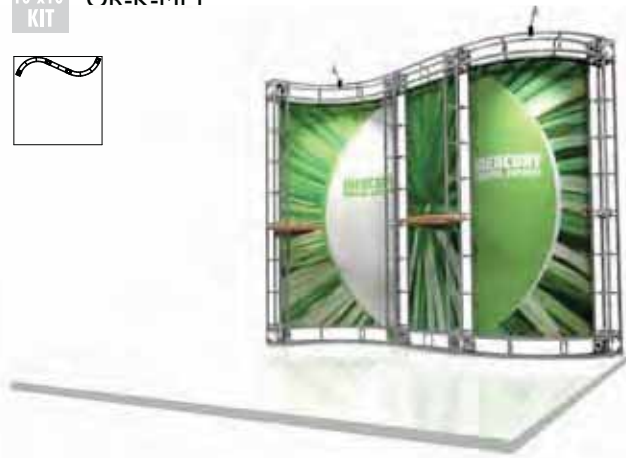
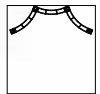

### MARS

### PAVO

10'x10' KIT OR-K-MRI

10'x10' KIT OR-K-PAI

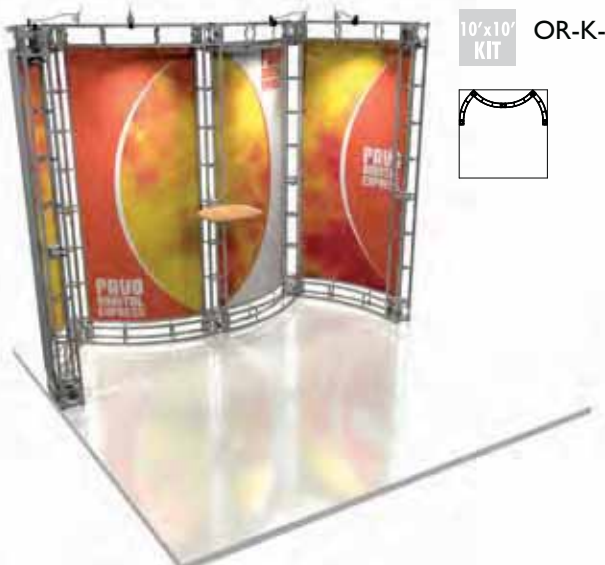
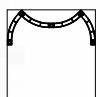

# CEPHEUS-2

## Most Excellent Productions Tradeshows

10'x20'  
KIT

OR-K-CEI-2

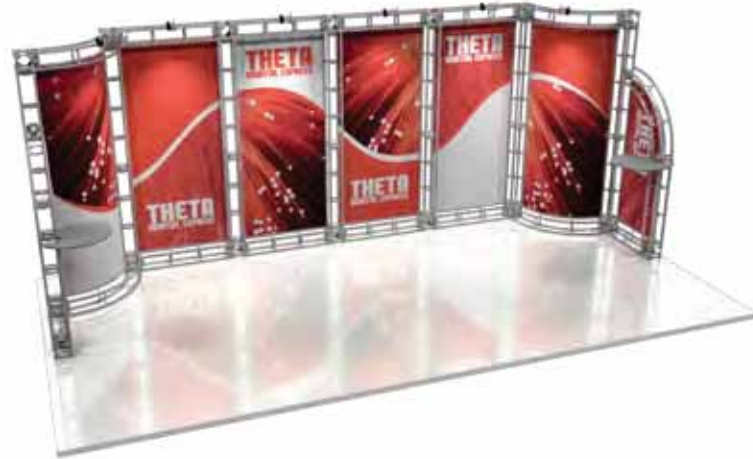
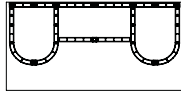

# THETA

10'x20'  
KIT

OR-K-THI



# PICTOR

10'x20'  
KIT

OR-K-PCI

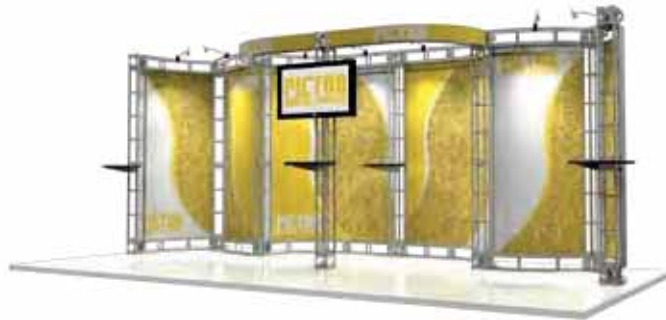
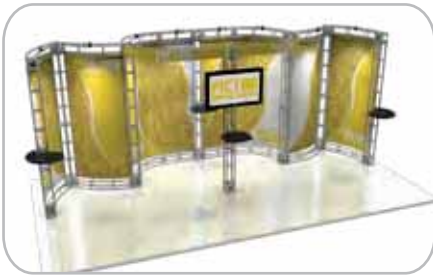
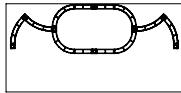

# INDUS

10'x20'  
KIT

OR-K-INI

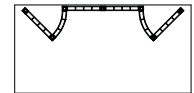

416 795 7400 Mike@mxp.to

### ANTARES

### Most Excellent Productions Tradeshows

10'x20'  
KIT OR-K-AT1

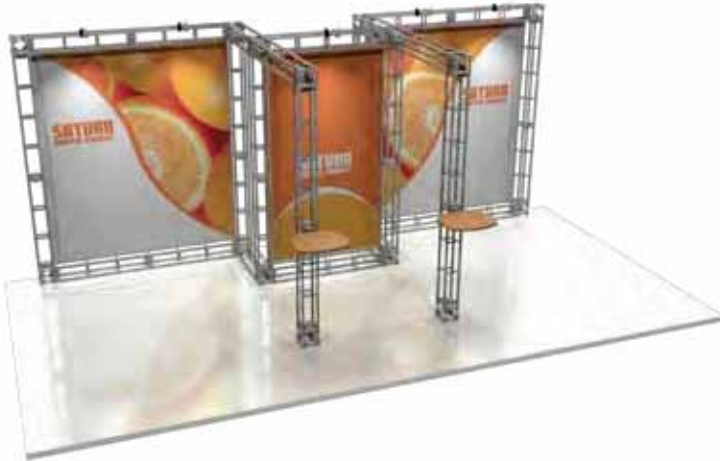
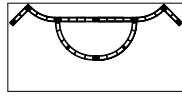

### SATURN

10'x20'  
KIT OR-K-SAI

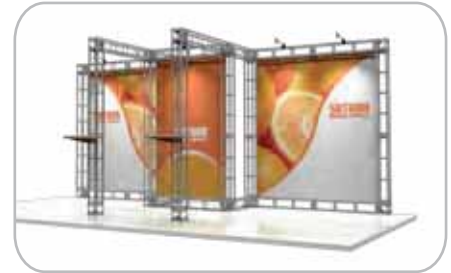
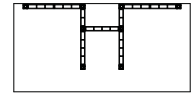

### ELECTRA

10'x20'  
KIT OR-K-ELI

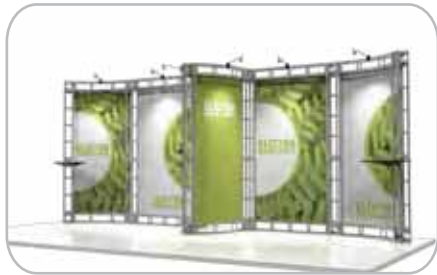
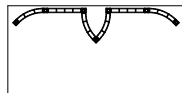

### PHOENIX

10'x20'  
KIT OR-K-PXI

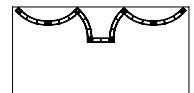



# POLARIS

## Most Excellent Productions Tradeshows

10'x20'  
KIT

OR-K-PR I

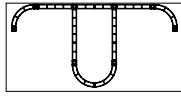

# OMICRON

10'x20'  
KIT

OR-K-OMI

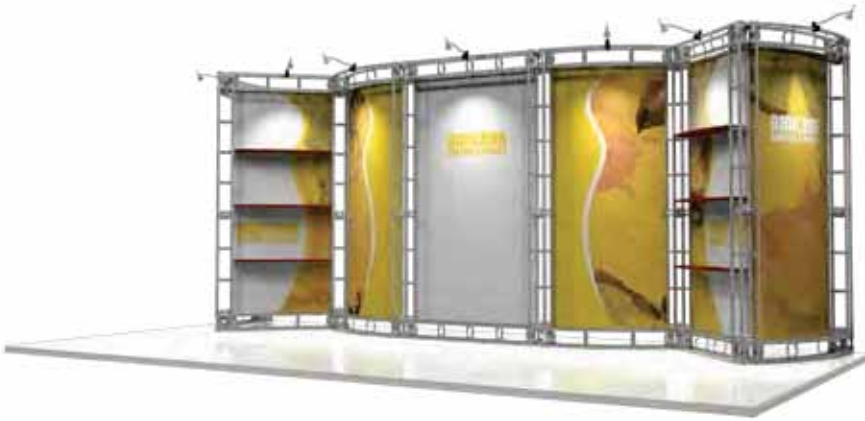
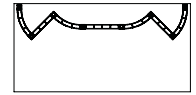

# ANDROMEDA

10'x20'  
KIT

OR-K-ADI

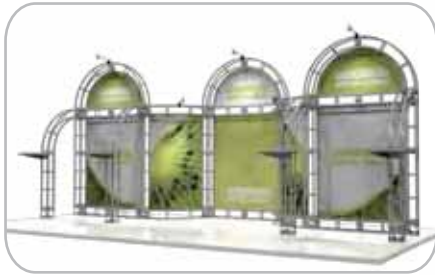
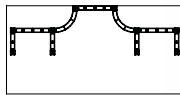

# ARCTURUS

10'x20'  
KIT

OR-K-ARI

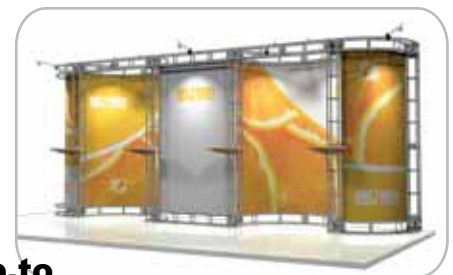
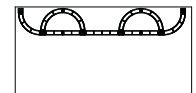

## VENUS

10'x20'  
KIT OR-K-VE1

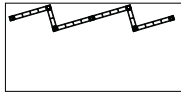

## Most Excellent Productions Tradeshows

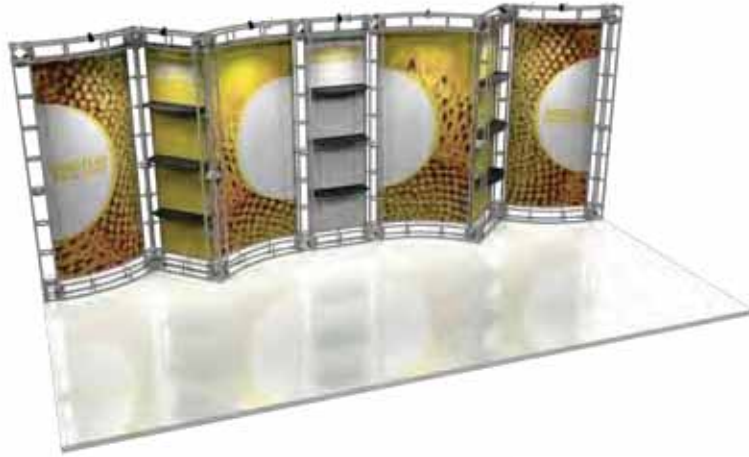

## MAGELLAN

10'x20'  
KIT OR-K-MGI

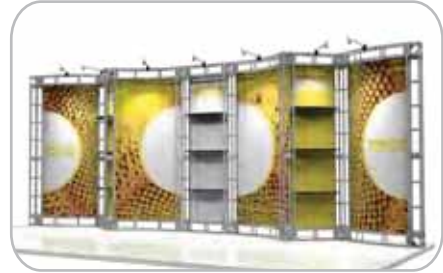
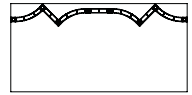

## HYDRUS

10'x20'  
KIT OR-K-HDI

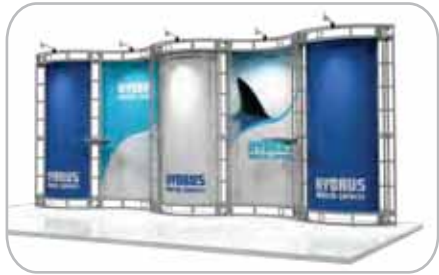
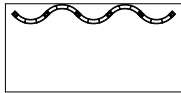

## LED

20'x20'  
KIT OR-K-LE1

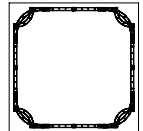

# DORADO

## Most Excellent Productions Tradeshows

20'x20'  
KIT

OR-K-DOI



# CORVUS

20'x20'  
KIT

OR-K-CVI

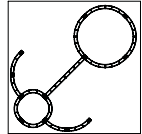

# CENTAURUS

20'x20'  
KIT

OR-K-CNI

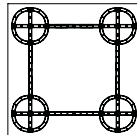

# NEPTUNE

20'x20'  
KIT

OR-K-NPI

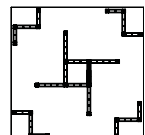

416 795 7400 Mike@mxp.to

tower also sold separately: OR-K-NPT

# TUCANA

20'x20' KIT OR-K-TUI

## Most Excellent Productions Tradeshows

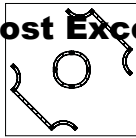

tower also sold separately: OR-K-TUT



# ORION

20'x20' KIT OR-K-ORI

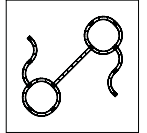

# VEGA

20'x20' KIT OR-K-VGI

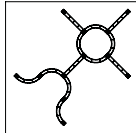

# ALTAIR

20'x20' KIT OR-K-ALI

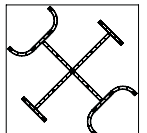

**Most Excellent Productions Tradeshows**



20'x20'  
KIT

OR-K-CAI

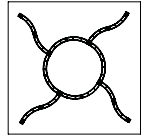

**DRACO**

20'x20'  
KIT

OR-K-DRI

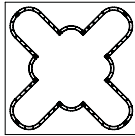

**JUPITER**

20'x20'  
KIT

OR-K-JPI

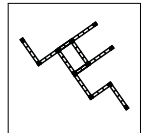

**OCT**

- large, round, general purpose freight case
- designed to handle national & international exhibit freight shipments
- offers maximum protection for your exhibit materials
- stackable and can be moved using the built-in castors or with a forklift



**OCF**

- offers the same features and benefits of the OCT in a rectangular shape
- shipping size= 51" w x 22" h x 38" d



416-795-7400 Mike@ [email address] 43" h x 47" d

# TRUSS COUNTERS

**Most Excellent Productions Tradesnews**

- several attractive designs to chose from
- sleek plex top option available
- 4 tabletop colors available
- no tools required for assembly



tops are available in your choice of finishes



Silver Black Mahogany Natural



shown with optional front graphic panel



shown with optional plex stand-off

plastic connectors make it easy to assemble



plex accent attaches with screw-on stand-offs

## RECTANGLE



OR-TC01  
rectangle - standard



OR-TC01-P  
rectangle - with plex stand-off and internal shelf

## OVAL



OR-TC02  
oval - standard



OR-TC02-P  
oval - with plex stand-off and internal shelf

## RACETRACK



OR-TC03  
racetrack - standard



OR-TC03-P  
racetrack - with plex stand-off and internal shelf

## CURVE



OR-TC04  
curve - standard



OR-TC04-P  
curve - with plex stand-off and internal shelf

tops are available in your choice of finishes

- easy to assemble
- perfectly complements your Orbital truss display
- your choice of 4 tabletop colors
- 5 shapes to chose from
- plex stand-off option available on all kits



square shown with plex option OR-P05-P



circle OR-P01



teardrop OR-P02



eye OR-P03



racetrack OR-P04



square OR-P05

LAMINATE TABLETOPS

NATURAL



OR-TBL-WD

MAHOGANY



OR-TBL-DWD

SILVER



OR-TBL-S

BLACK



OR-TBL-B



right facing: OR-TBL2-R-WD  
left facing: OR-TBL-L-WD



right facing: OR-TBL2-R-DWD  
left facing: OR-TBL2-L-DWD



right facing: OR-TBL2-R-S  
left facing: OR-TBL2-L-S



right facing: OR-TBL2-R-B  
left facing: OR-TBL2-L-B

LIT RACK

OR-STG



- 10 pocket clamp on literature rack
- sleek design
- note: rack may not fit into the standard kit packaging solution/ molded case



OPTI MOUNT

- adjustable angles up to 30°



OR-LCD-1-S

Opti-Mount 1  
15"-30" LCD  
max weight= 30 lbs

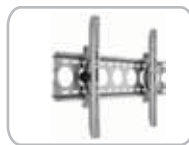

OR-LCD-3-S

Opti-Mount 3  
30"-50" LCD  
max weight= 130 lbs

INTERNAL SHELVING

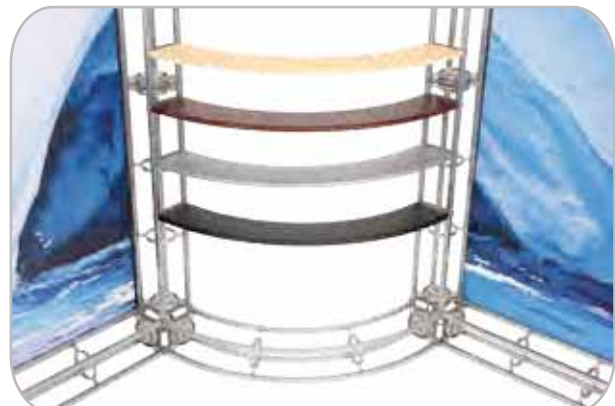

- available in all 4 finishes (light wood, mahogany, silver & black)
- 24" straight span, 36" straight span, and 46" straight span shelves available
- 45° curved and 90° curved shelves (shown above)

416 795 7400

Mike@mxp.to

Most Excellent Productions Tradeshows



**ZEDUP 1**

black: ZD-1-B  
silver: ZD-1-S

- 6 pocket rack
- can be stored or shipped loaded with literature

hard case upgrade:  
black: ZD-1-HC-B  
silver: ZD-1-HC-S



**ZEDUP LITE**

silver: ZD-LITE

- 6 pocket rack
- collapsible
- lightweight version of the ZedUp
- constructed from aluminum & plastic for reduced weight



**ILLUSION**



Illusion 1 single width  
black: IL-1-B, silver: IL-1-S  
Illusion 2 double width  
black: IL-2-B, silver: IL-2-S

- fast-folding cantilever rack
- 4 front facing pockets



**10 UP**

black: 10UP-B



- strong & stable
- 10 pockets
- packs flat



**VICTORY**

black: VIC-B  
silver: VIC-S



- slim, modular, snap-together design



**TITAN**

black: TITN-B



- modular design
- heavy duty
- 8 pocket
- packs in 3 separate parts for reduced shipping size



**INNOVATE**

black: INN-B  
silver: INN-S



- modular design
- 10 pockets
- packs in 3 separate parts for reduced shipping size





## Most Excellent Productions Tradeshows



### LUMINA 1

silk black: LUM-1-B  
chrome: LUM-1-C

- low voltage 50 watt spotlight
- "goose neck" arm
- mounts horizontally

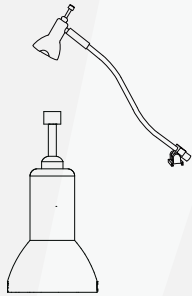

### LUMINA 2

LUM-2

- low voltage 35 watt slender spotlight
- mounts to a vertical pole
- brushed stainless steel finish

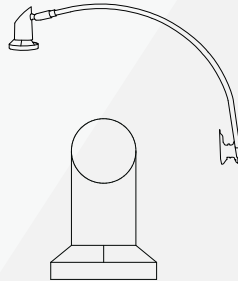

### LUMINA SPARE BULB KIT LUM-BULB

- (2) 50 watt low voltage spare bulbs in a padded, protective EVA formed case



### UNIVERSAL LIGHT CLAMP KIT UNI-LT-CLP

- comes standard with the Lumina 1, 3, 4, 5, 6, 8, 9, 10, 11, 12, 13 and allows our lights to fit a majority of banners, truss & panel kits



### LUMINA 200

LUM-200 ORL

- 110 volt ETL approved wall washer floodlight with a straight arm & adjustable head
- light includes 200 watt halogen bulb
- 19.5" (495.3 mm) long from end to end
- silk black finish

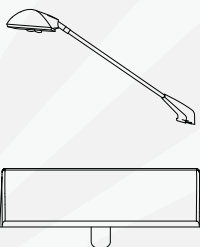

### LUMINA 200 LED

LUM-LED-ORL-B

- LED version of the Lumina 200 floodlight
- 1400 Ma, 12VDC
- LED rated for 20,000 continuous hours

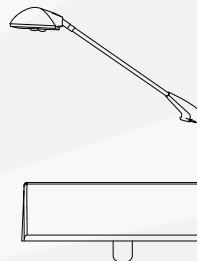

### LED BULB OPTION

- MR11: LUM-LV-LED-BLB11  
- a green solution for Lumina 2  
- 3 watt LED bulb
- MR16: LUM-LV-LED-BLB16  
- a green solution for Lumina 1, 3, 4, 5, 6, 8, 9, 10, 11, 12, & 13  
- 5 watt LED bulb



MR11

MR16

**OCA2** **NEW**

- attaches to the OCFM or OCHM for easy transport of accessories
- ideal for lights and accessories associated to other products
- secure straps help to assure case will remain closed during transport



**OCHM** **NEW**

- interlocking surface to enable two cases to be transported together
- maximum case depth= 8" allowing up to 8 flat panels per case



**OC-HOP** **NEW** **OCM** **NEW**

**Most Excellent Productions Trade Shows**

- ideal for Hopup backwall displays
- built-in handle and wheels for easy transport



- black LLDPE Polyethelene case designed for LCD monitors
- built in dry erase board to label contents and location
- fits 37" - 47" screens
- made from 100% recycled materials
- 40"h x 54"w x 16"d (with wheels)
- 69lbs, empty weight
- includes 3" casters with rubber wheels
- must be shipped freight



**OCH**

- blow molded case for exhibits, graphics & accessories
- reliable built in wheels
- easy to grip molded handles
- secure reinforced straps help to assure case will remain closed during transport
- strong yet lightweight



**OCH2** **NEW**

- heavy-duty shipping and storage case
- ideal for Linear hybrid displays
- built in wheels and handle
- secure reinforced straps help to assure case will remain closed during transport



**OCFM** **NEW**

- interlocking surface to enable two cases to be transported together
- maximum case depth= 8" allowing up to 8 flat panels per case



**OCF2** **NEW**

- molded stackable shipping crate 18" deep
- heavy-duty roller bearing recessed in bridge of case
- holds 18 layers of flat panels in horizontal direction



**LUMINA SPT CASE**

- EVA semi-rigid lighting case
- foam-lined padded compartments
- holds two Lumina lights & power supply



**LUMINA FLD CASE**

- EVA semi-rigid lighting case
- foam-lined padded compartments
- stores & transports two lights designed for use with Lumina models 1-5



**OASIS**  
OASIS



- highly portable
- three arm collapsible bag dispenser
- shiny silver finish



**STEP STOOL**  
STEP STOOL

- sturdy EZ FOLDZ step stool
- 300 lb capacity
- folds flat for storage and transport
- red only



**WEDGE**  
WED-B

- simple to use sign support
- combine multiple units for longer and taller displays
- graphic size is variable
- black only
- graphics not included



application shown uses multiple units



**BREEZE**

BREZ-1-S: 8.375" w x 11.25" h  
BREZ-2: 11" w x 17" h

- retractable tabletop stand
- ideal for custom calendars & other promotional banners



**VORT-X MINI**

red: VTX-MC  
blue: VTX-MC-BL

- quick & simple to assemble
- ideal for retail/POP use
- sold in packs of 2
- visual area= 12" w x 16.5" h



**SIGNATURE**

SIG-3 (3 pockets): 4.25" x 11"  
SIG-4 (3 pockets): 4.25" x 11"

- tabletop literature dispensers
- sold in packs of 2

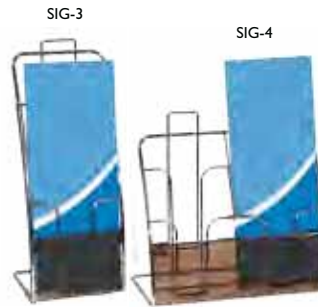

**TABLE ACE**

TB-ACE-1: 6" w x 12" h  
TB-ACE-2: 6" w x 24" h  
TB-ACE-3: 12" w x 24" h

- mini tabletop banner stands
- sold in packs of 3
- black only



**TRAPPA POSTER FRAME**

- silver anodized finish w/precision mitered corners
- snaps open for quick & easy graphic changes
- features spring loaded aluminum extrusions mounted to a high-impact polystyrene backer
- available in a wide range of standard sizes & includes a clear anti-glare lens



**APEX**

APEX

- double-sided plastic a-frame
- can be printed directly on the plastic for a smooth look
- for indoor or outdoor use



**SYNERGY**

SYN-2-1

- double-sided aluminum a-frame
- snap edges for quick graphic changes
- silver anodized finish



**Most Excellent Productions Tradeshows**

**BROUGHT TO YOU BY:**